

ISO(1). RECTANGULAR PRISM

Isometric View

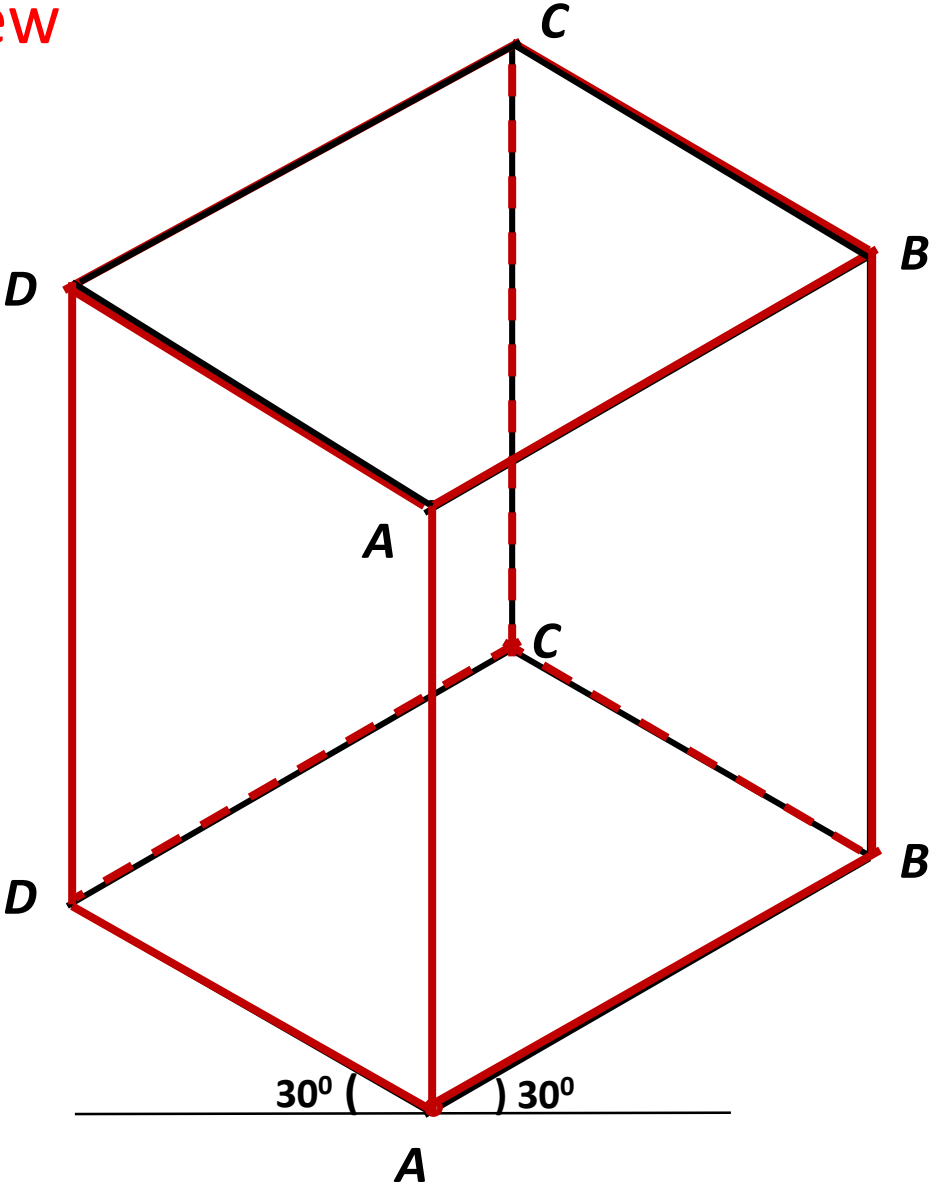
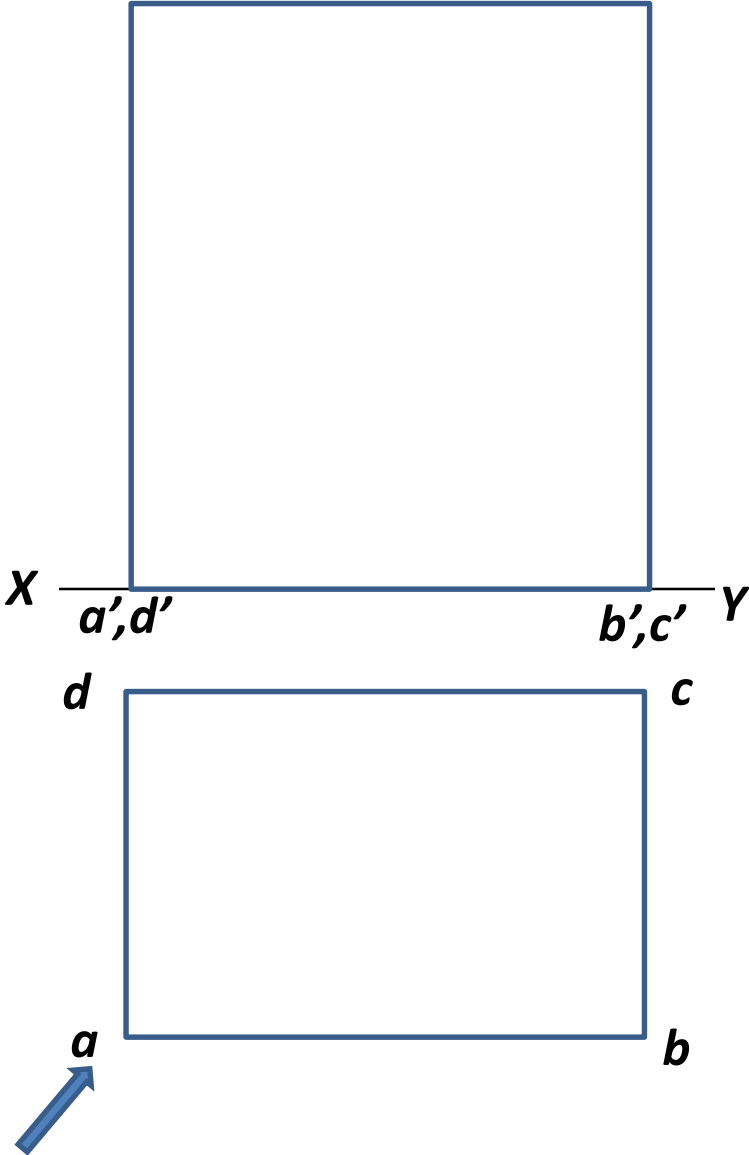

ISO(2). SQUARE PRISM

Isometric View

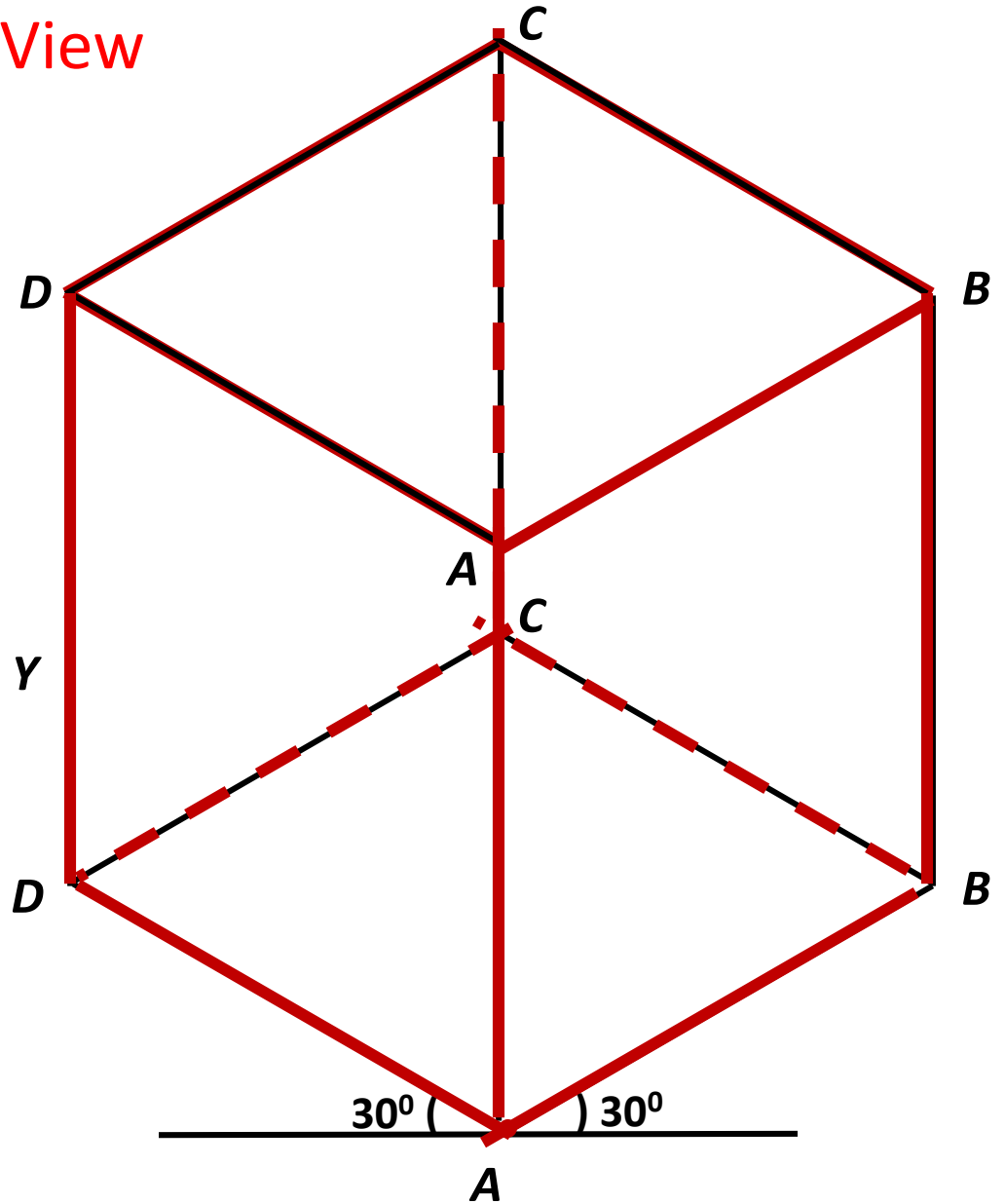
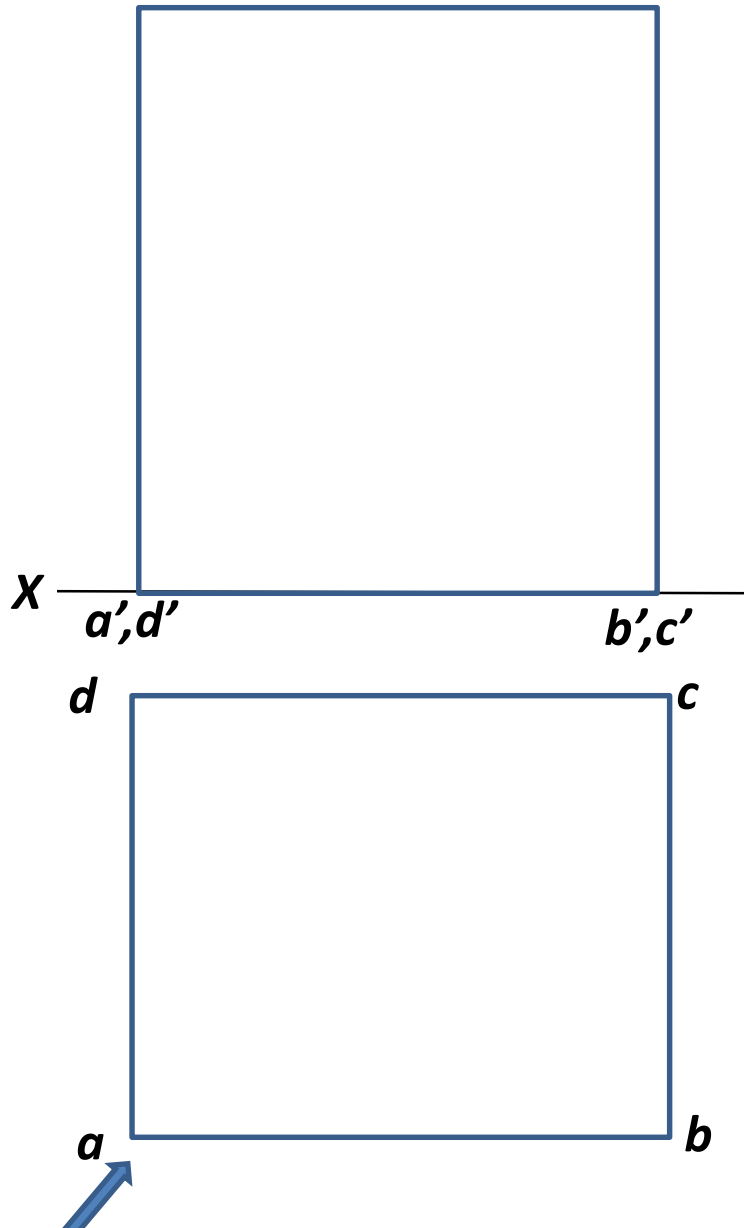

ISO(3). **CUBE**
Isometric View

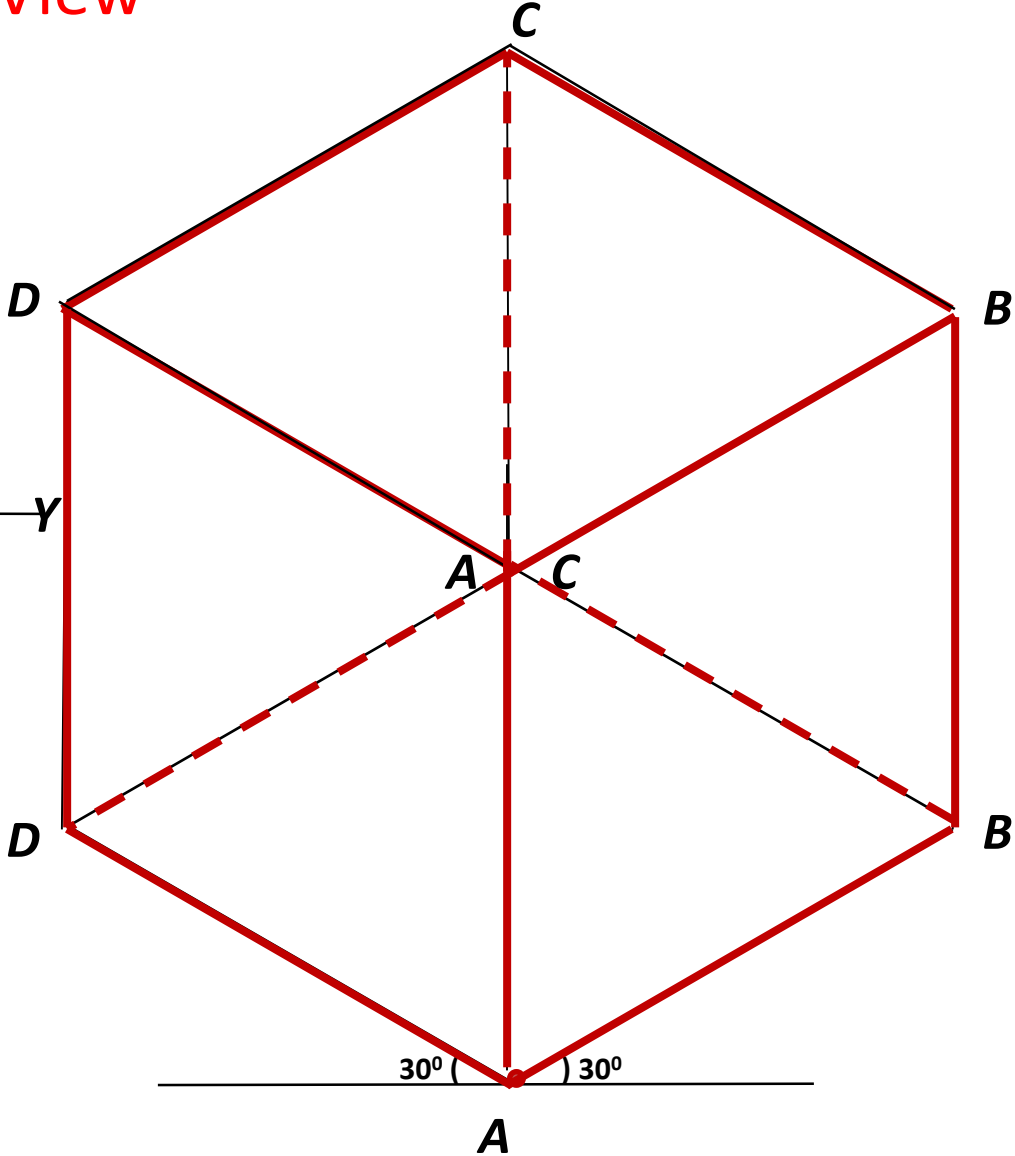
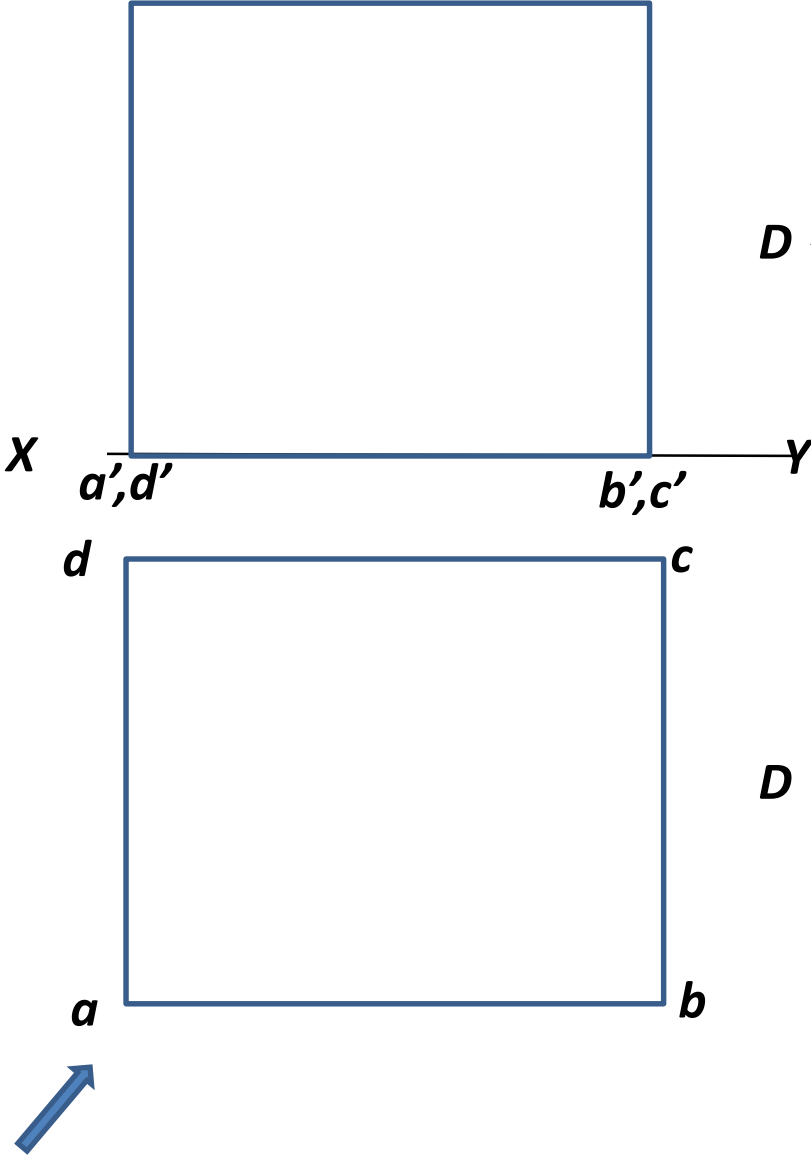

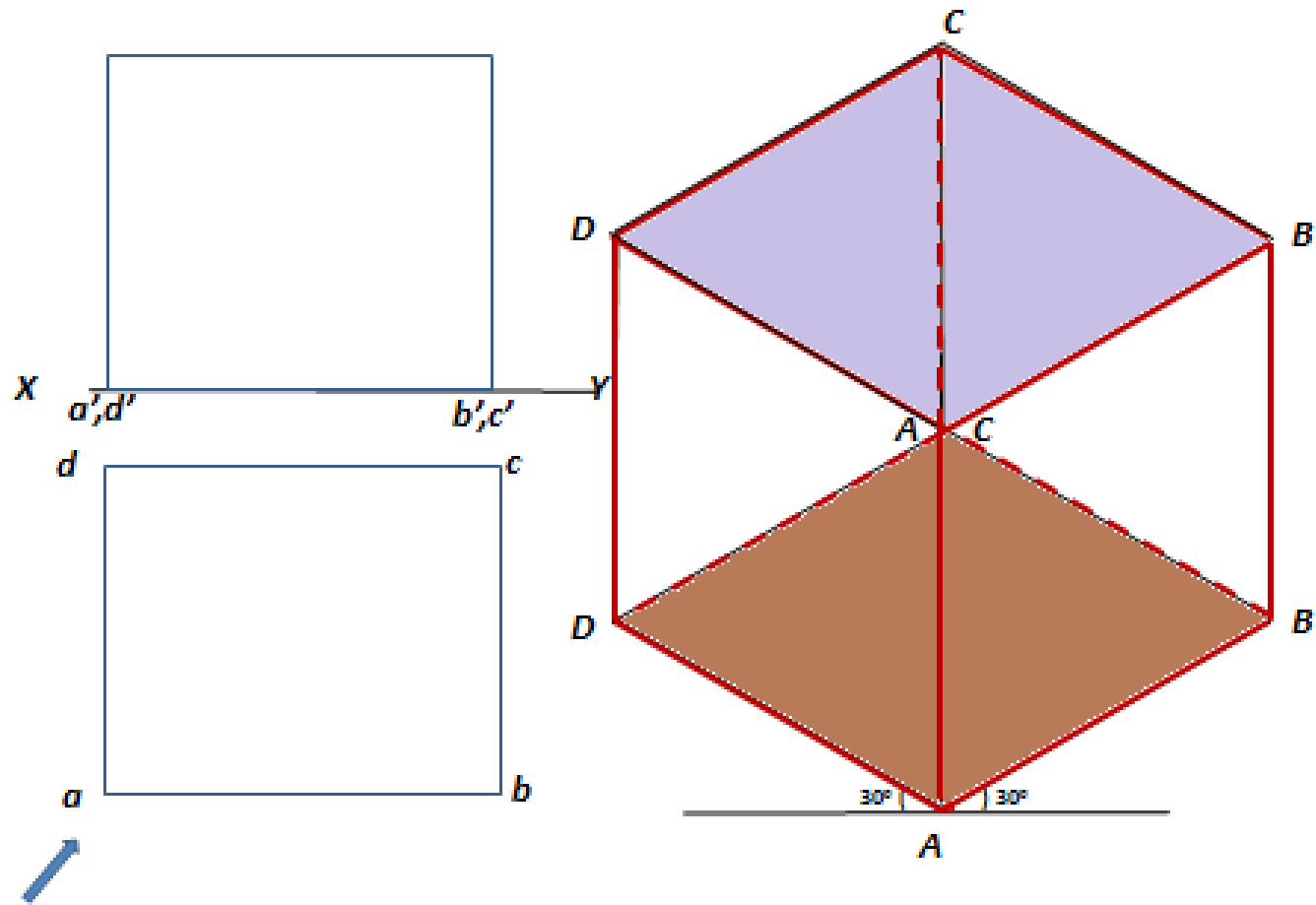

ISO(4). SQUARE PYRAMID
Isometric View

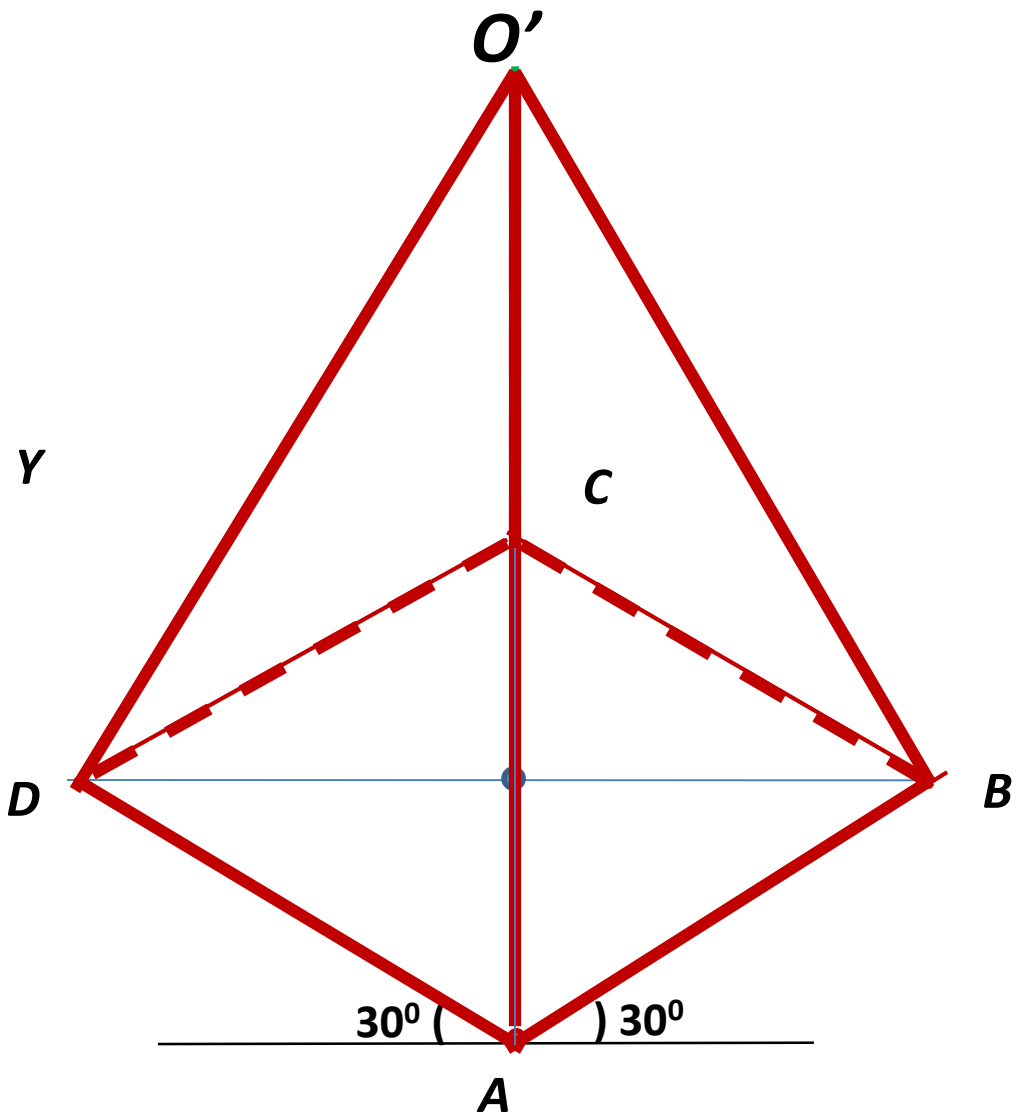
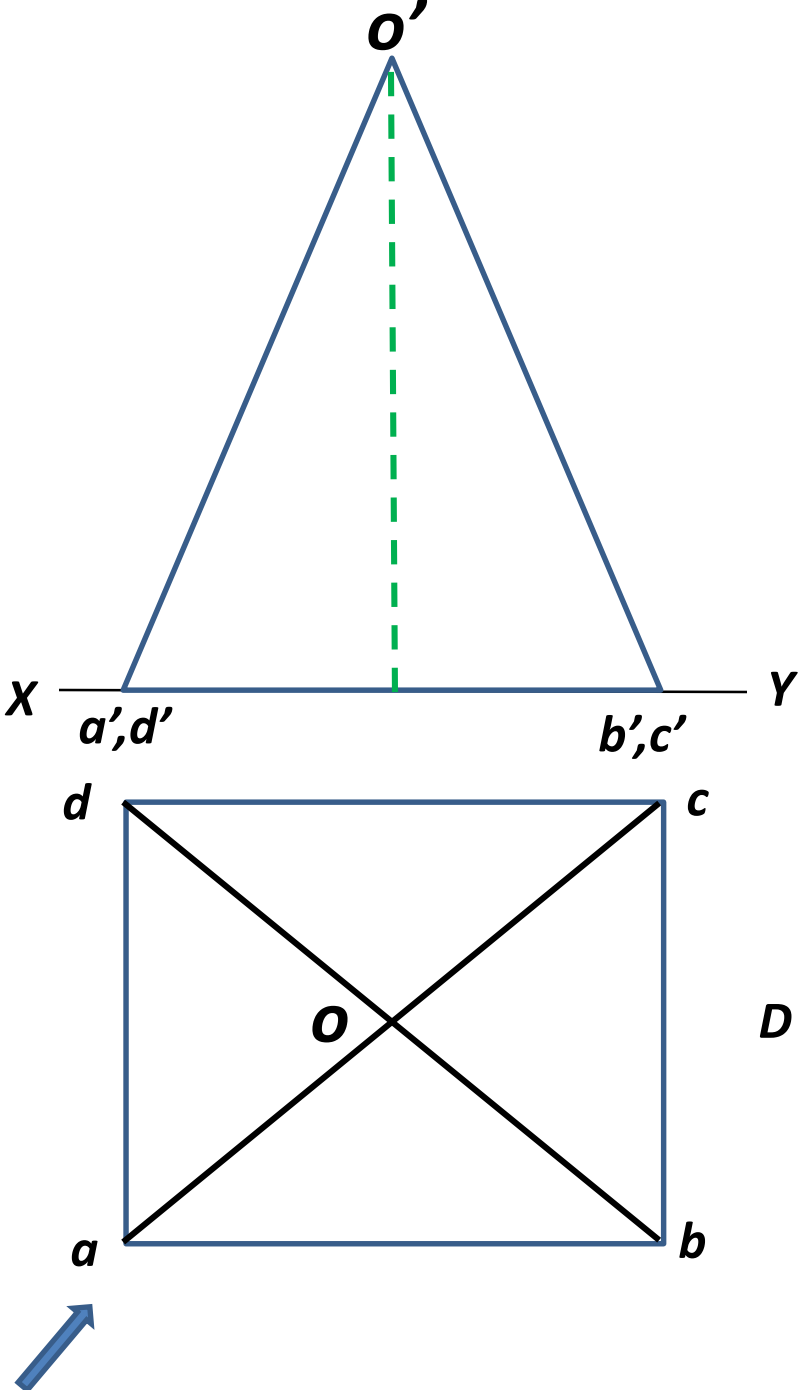

ISO(5). HEXAGONAL PRISM

Isometric View

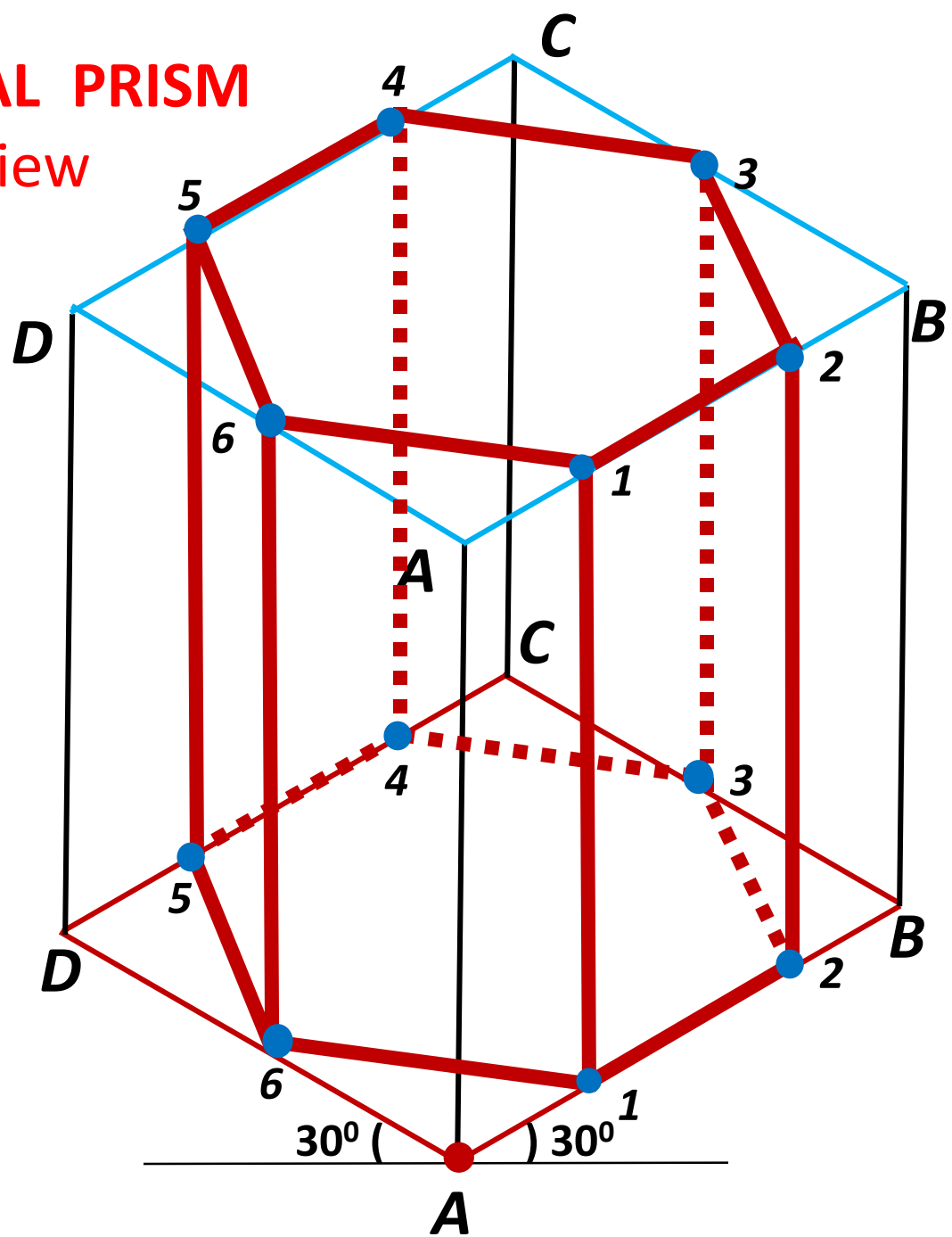
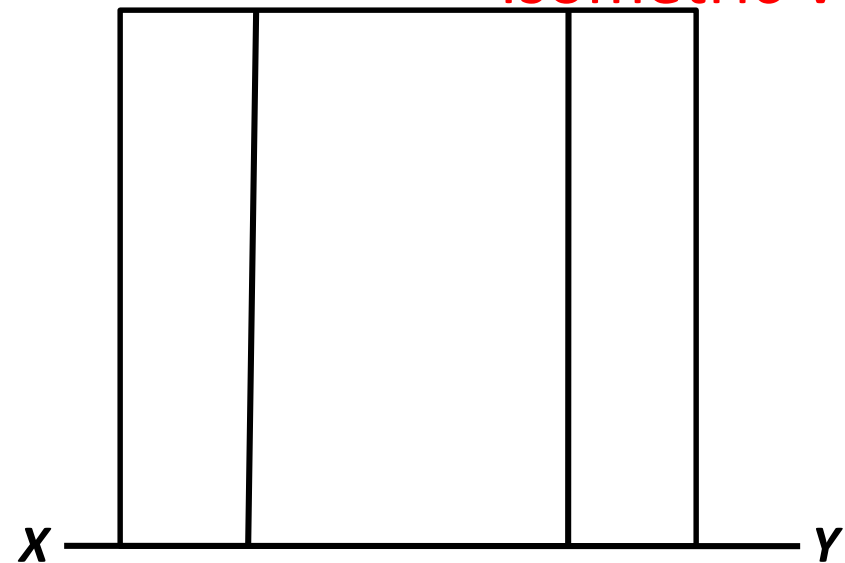

ISO(6). HEXAGONAL PYRAMID
Isometric View

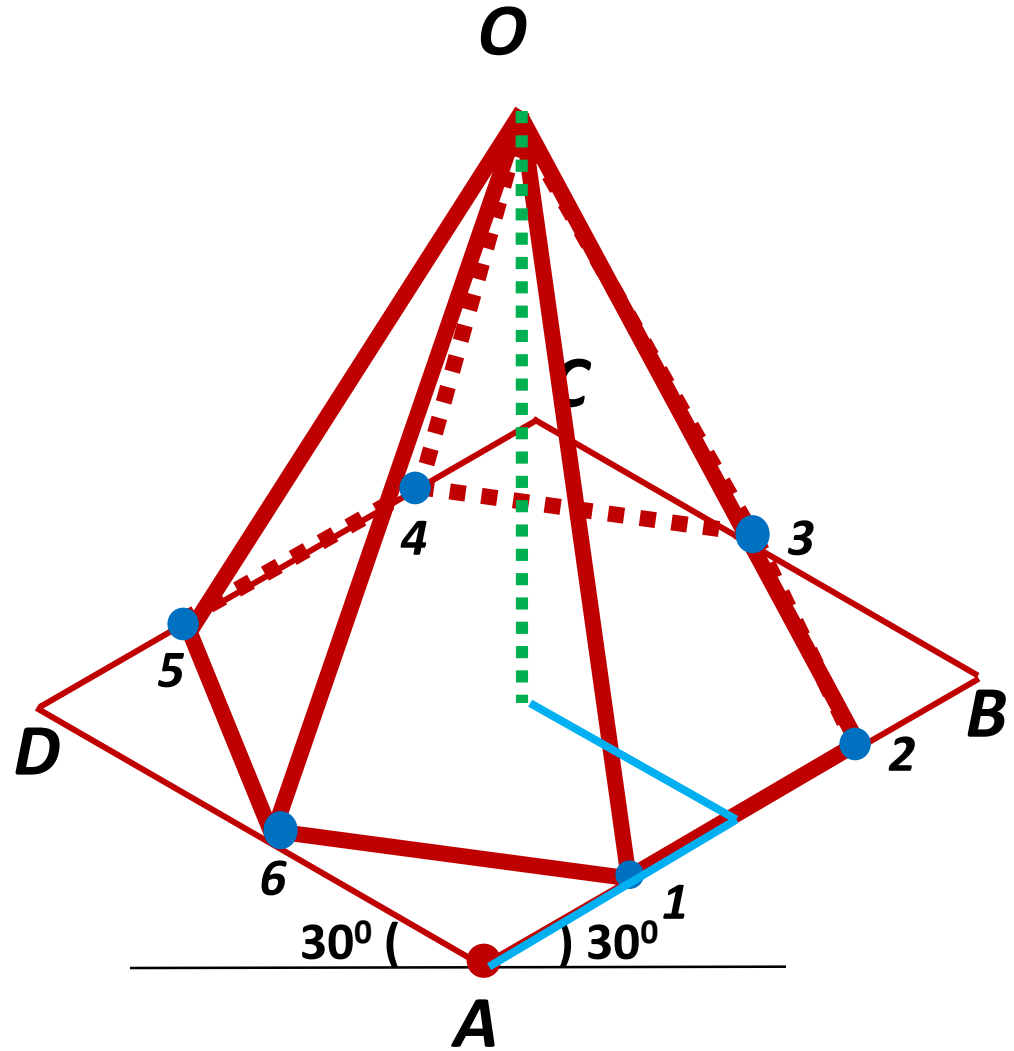
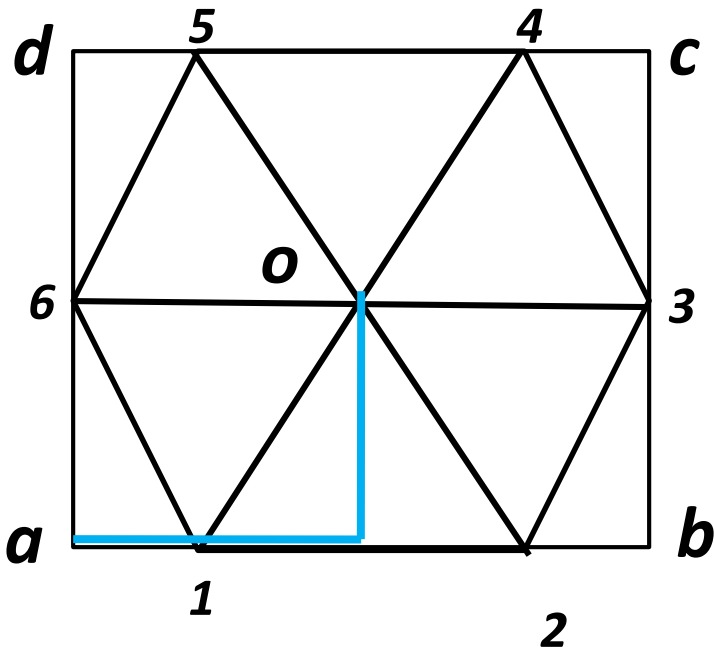
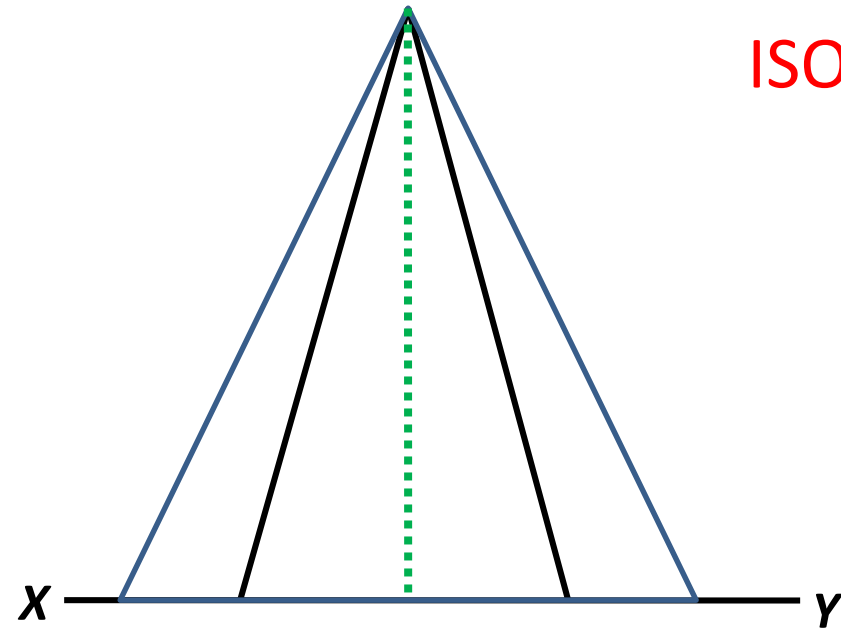

ISOMETRIC SCALE

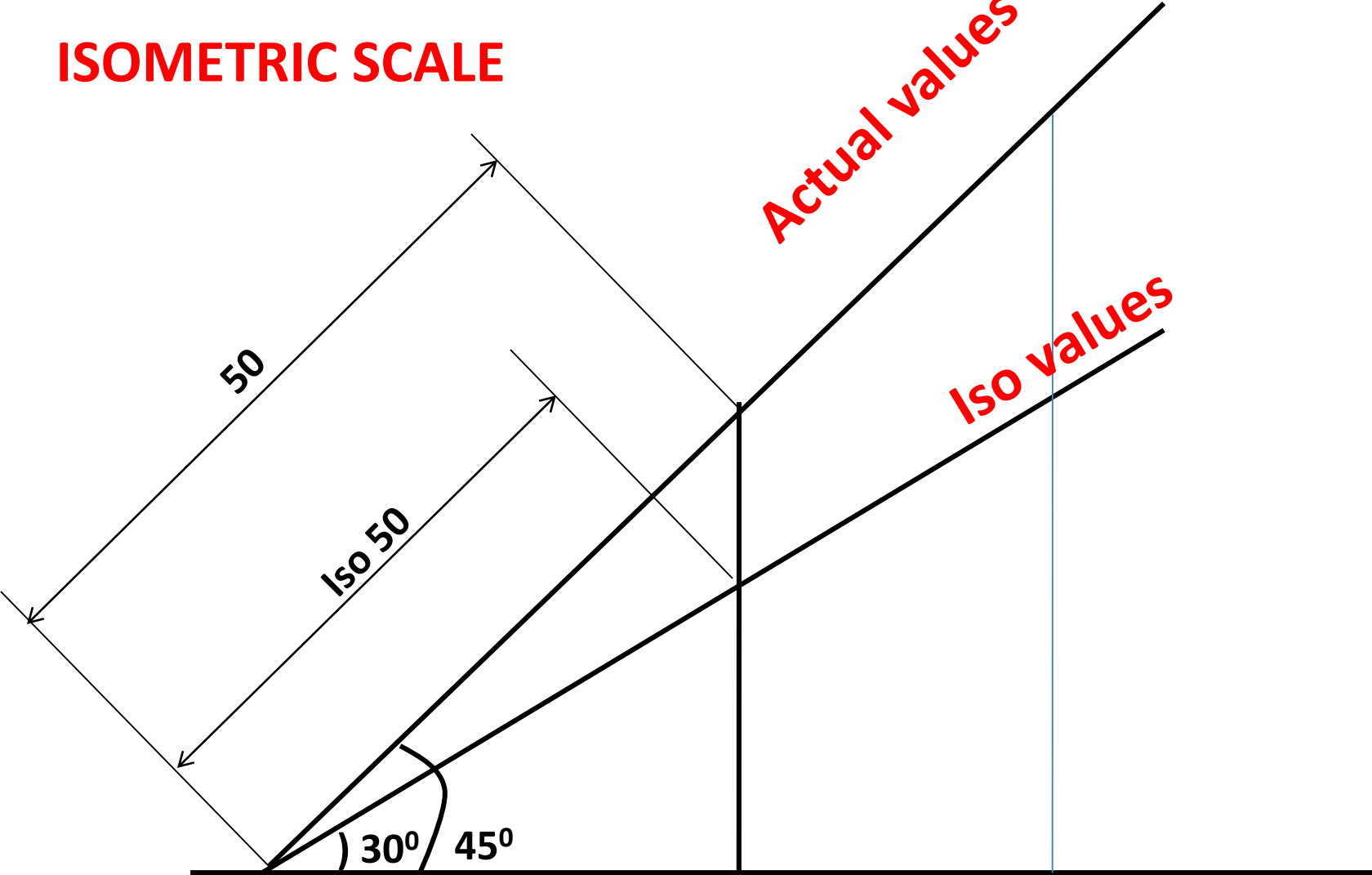

ISO(7). TRIANGULAR PRISM

Isometric Projection

One Rectangular Face on HP

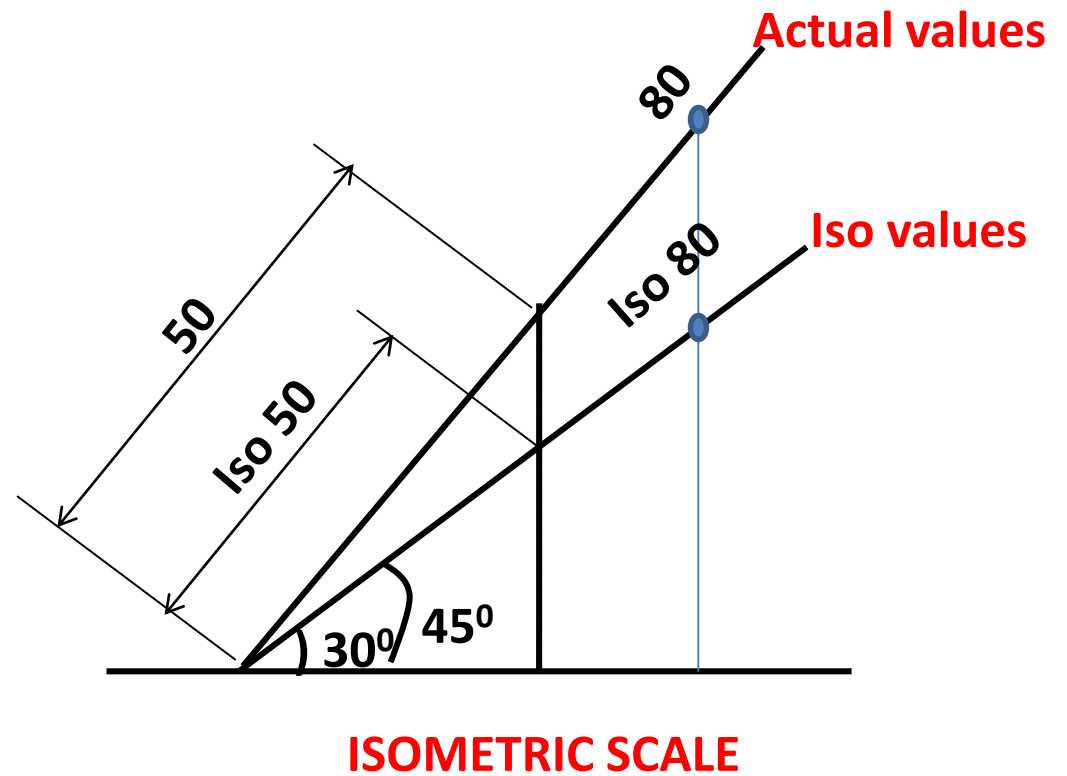
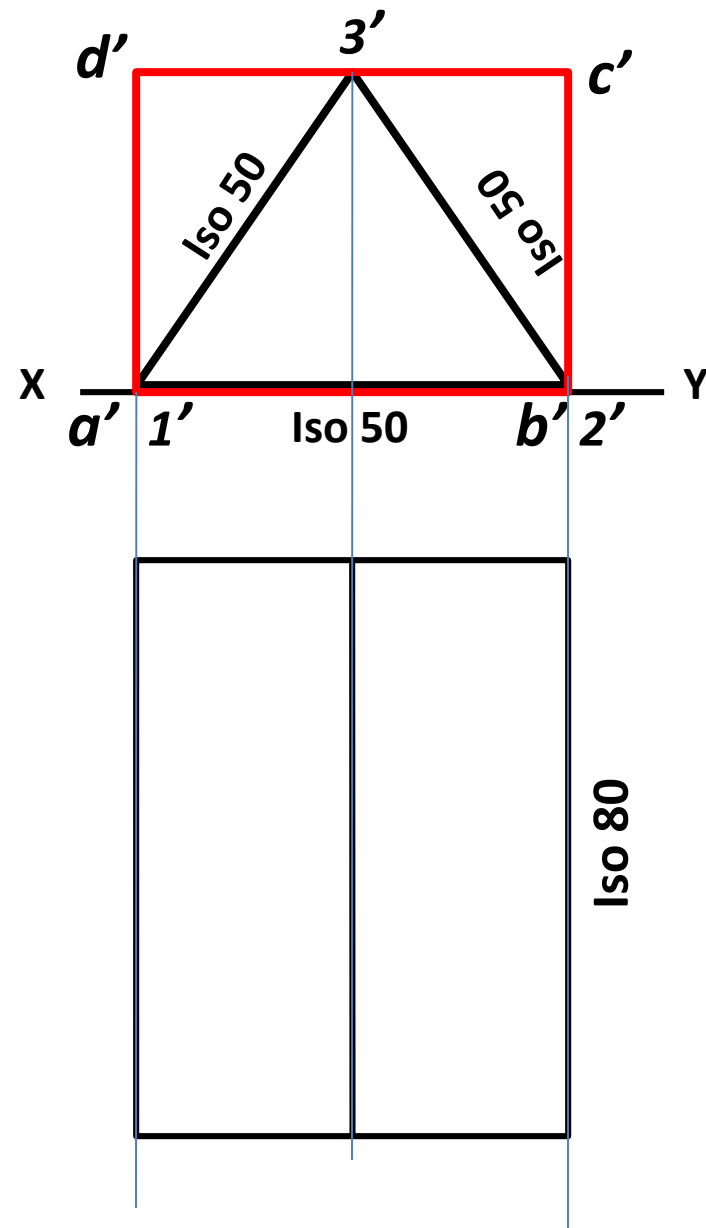

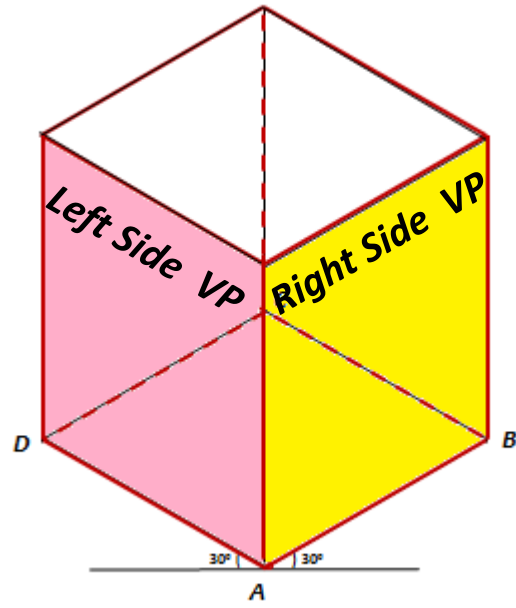
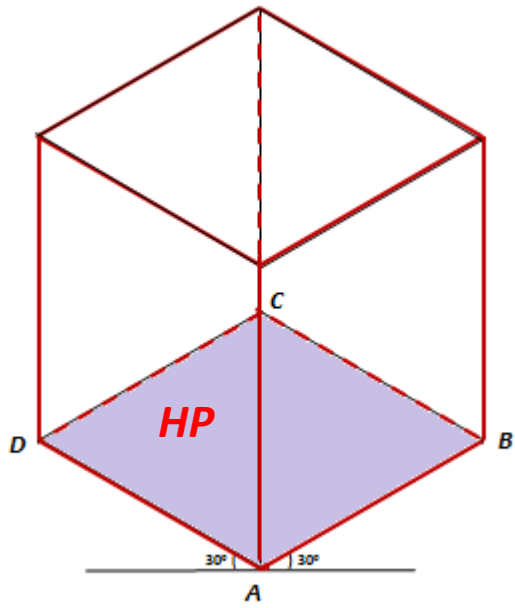

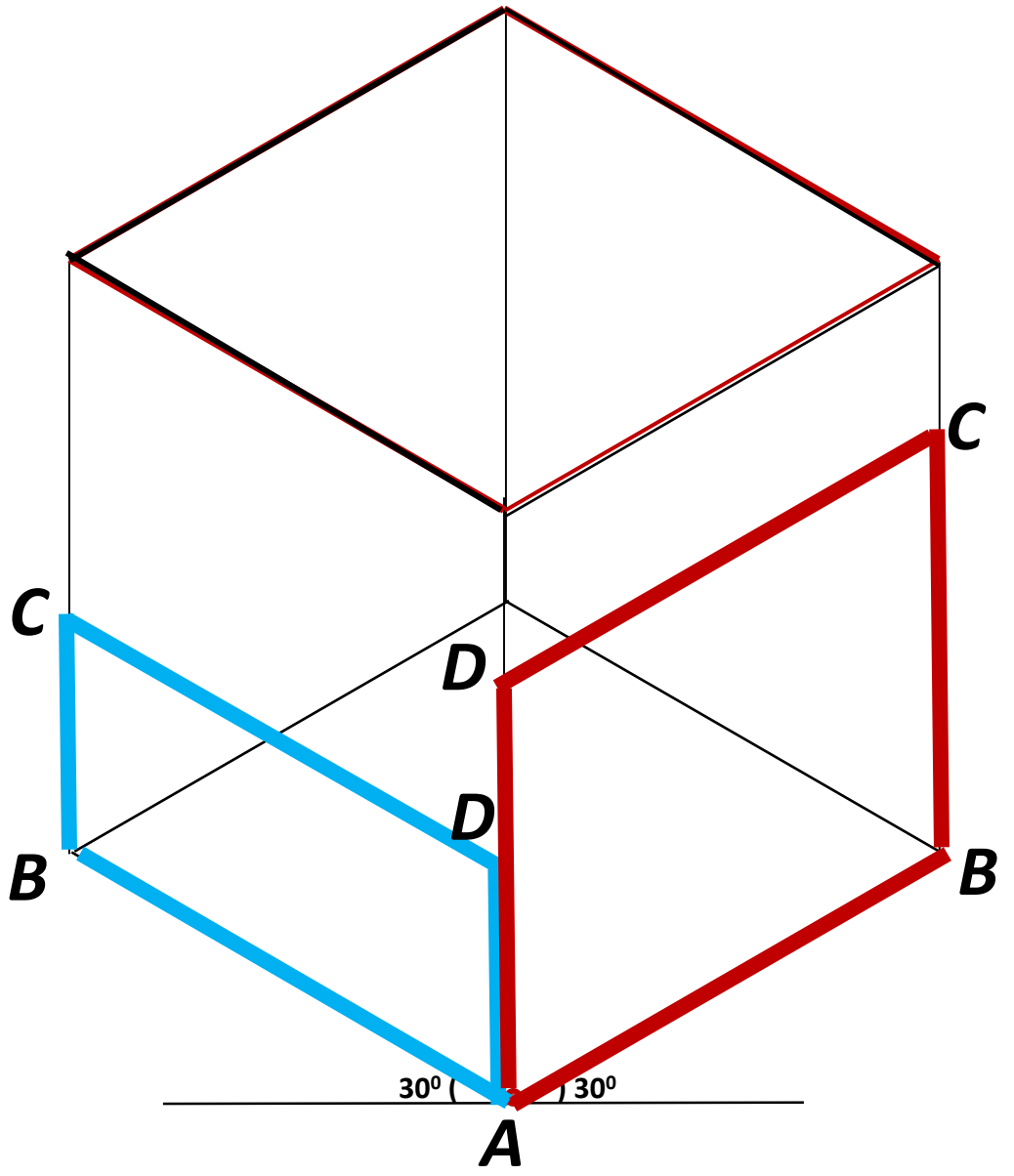
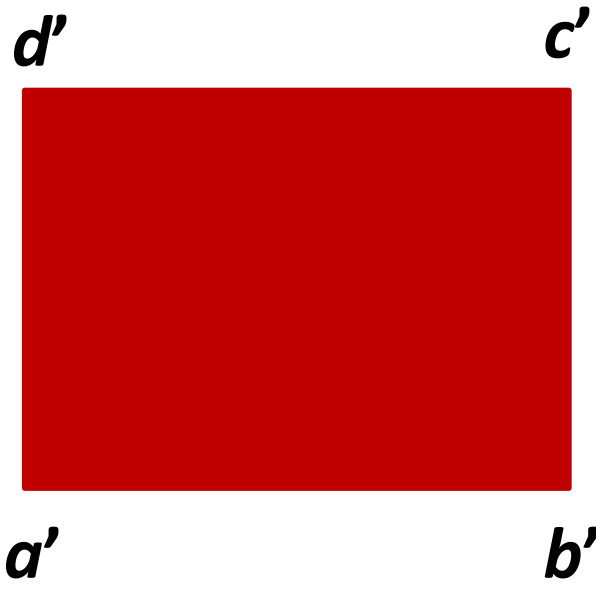

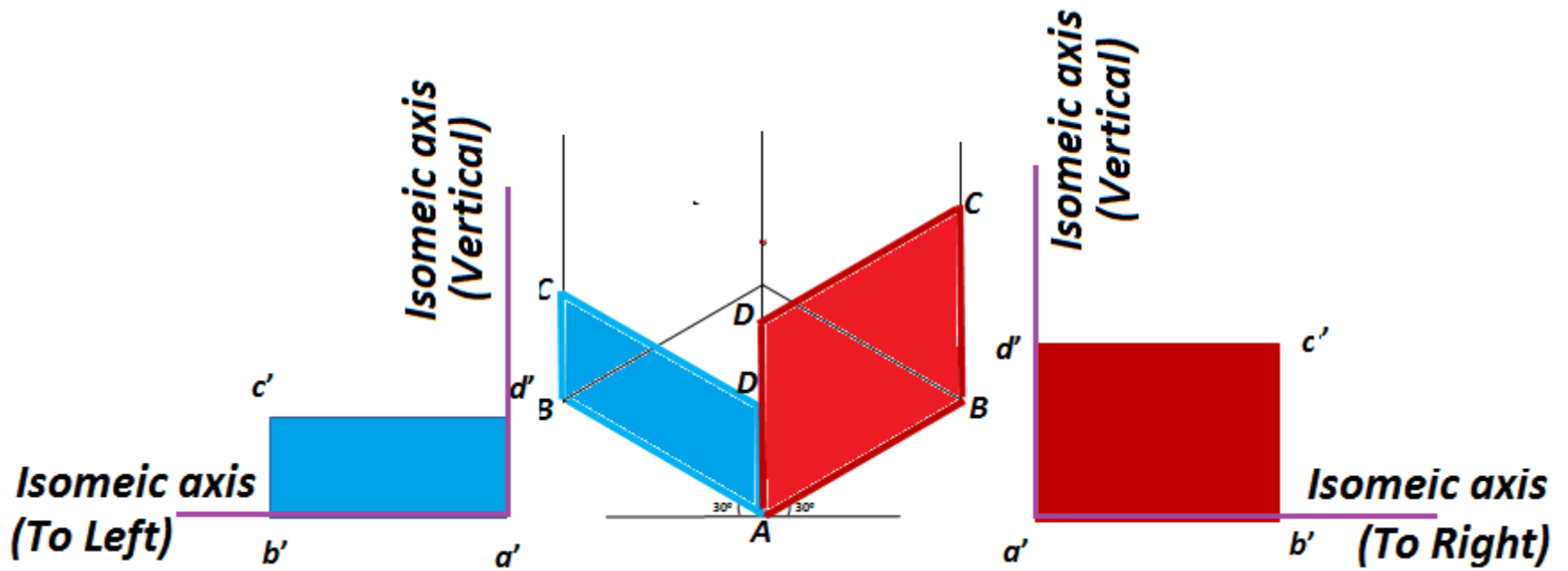

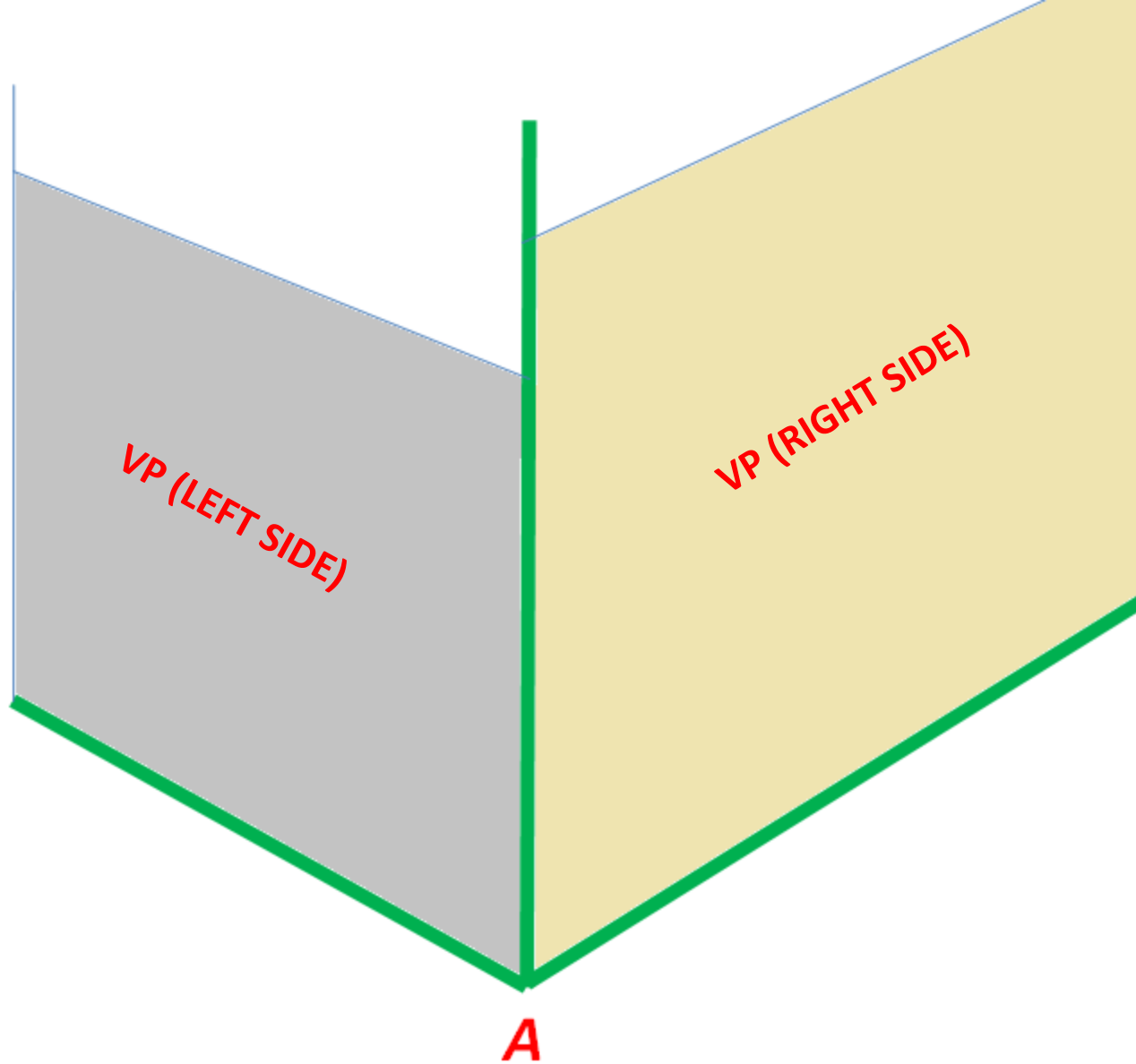

ISO(7). TRIANGULAR PRISM

Isometric Projection

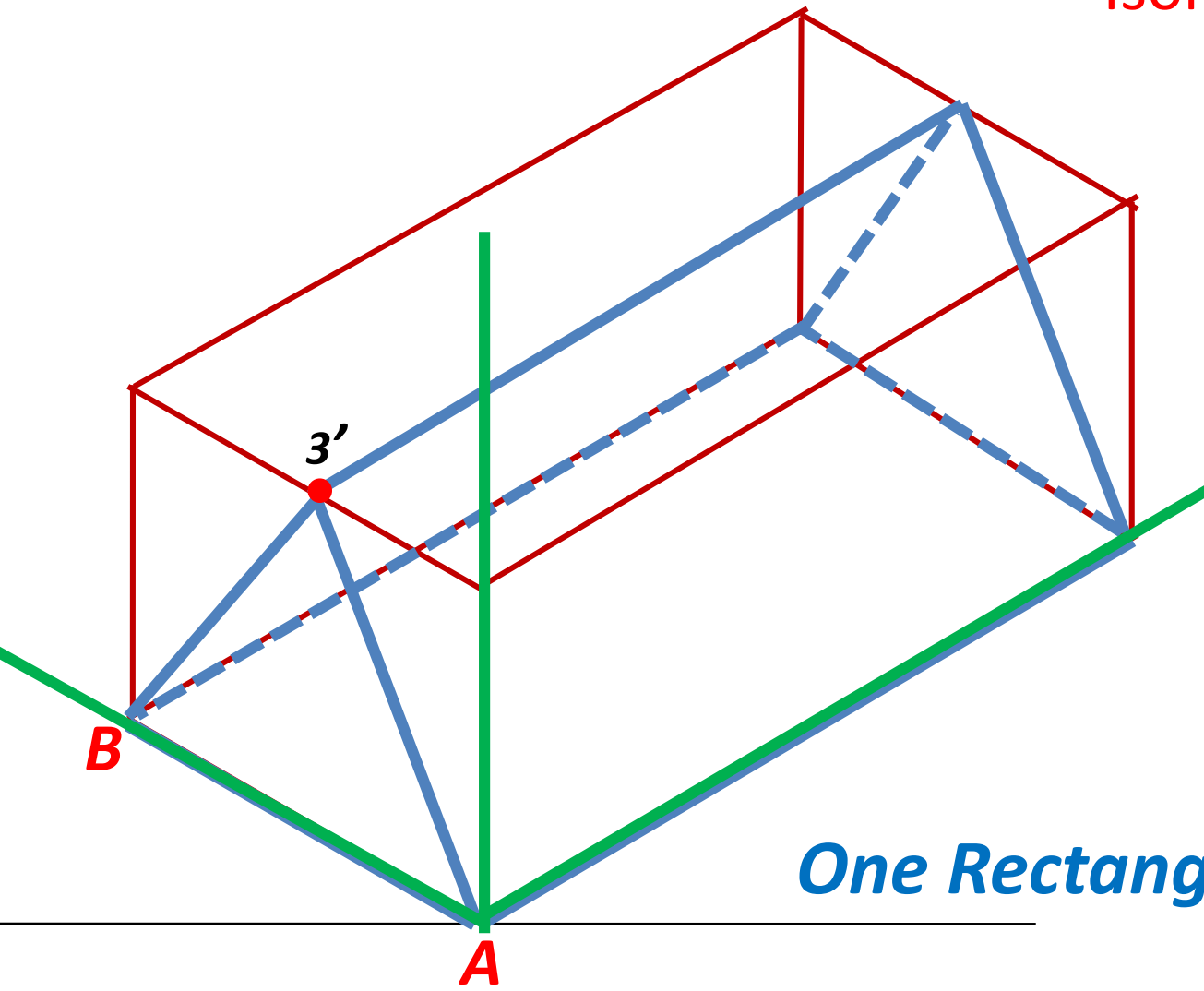

One Rectangular Face on HP

ISO(8). PENTAGONAL PRISM

Isometric Projection

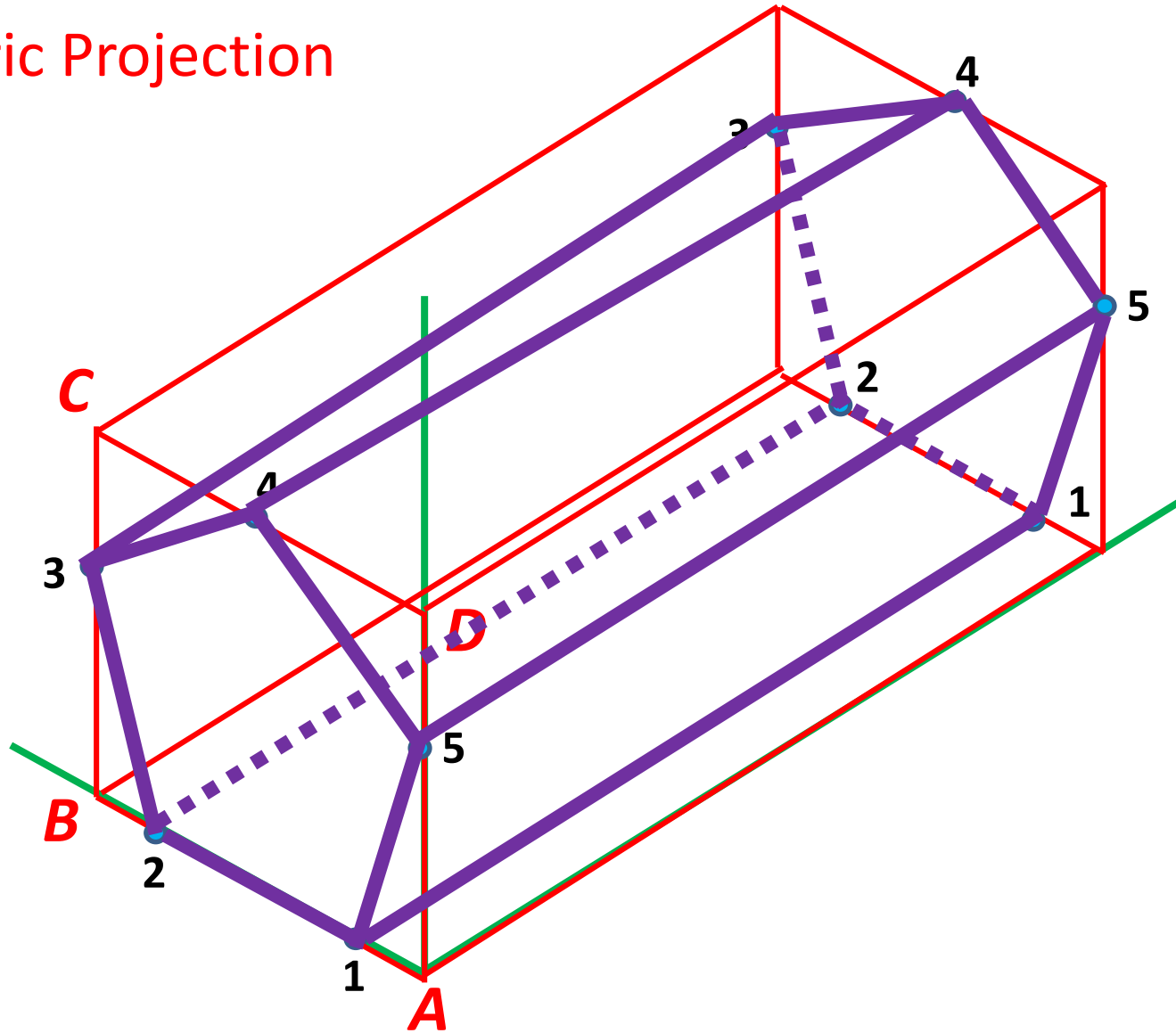
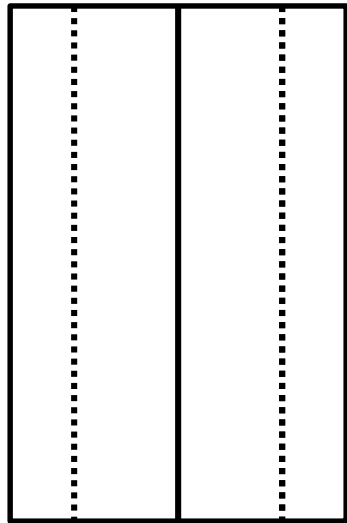
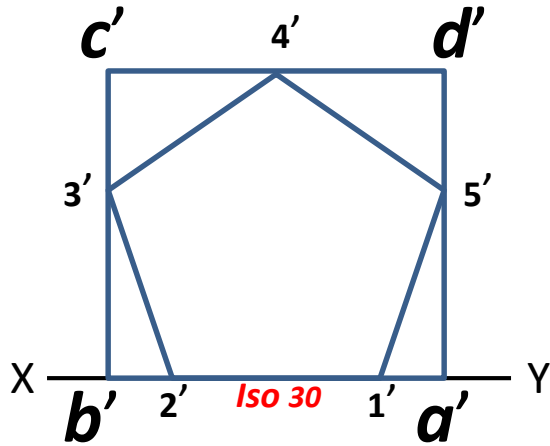

One Rectangular Face on HP

ISO(9). PENTAGONAL PRISM

Isometric Projection

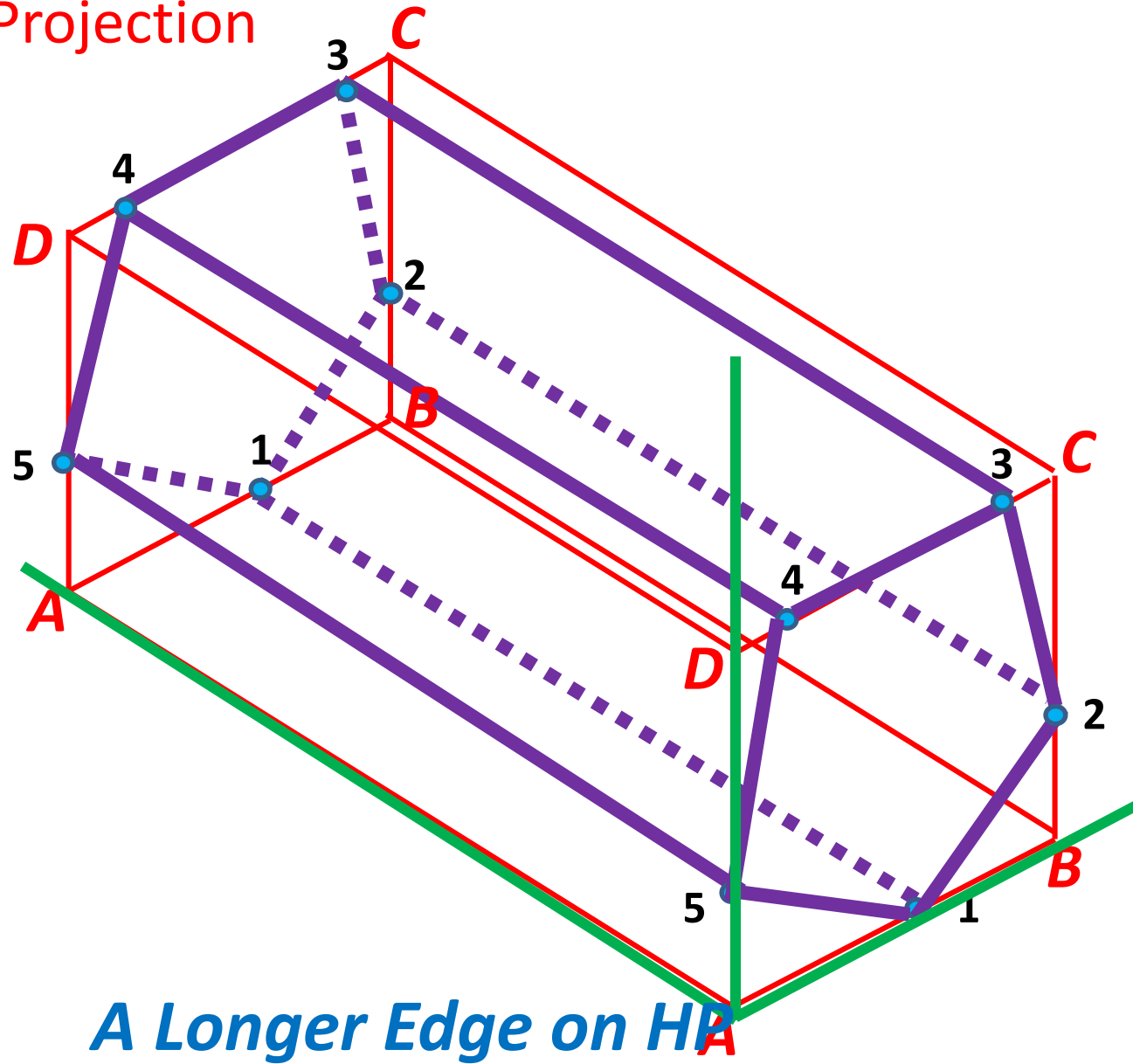
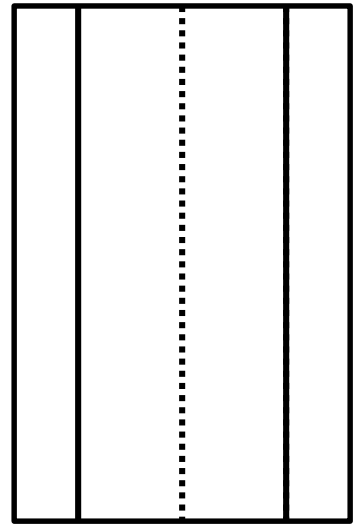
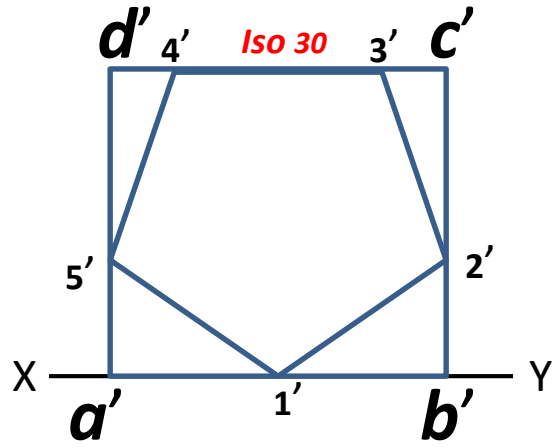

ISO(10). HEXAGONAL PRISM

Isometric Projection

One Rectangular Face on HP

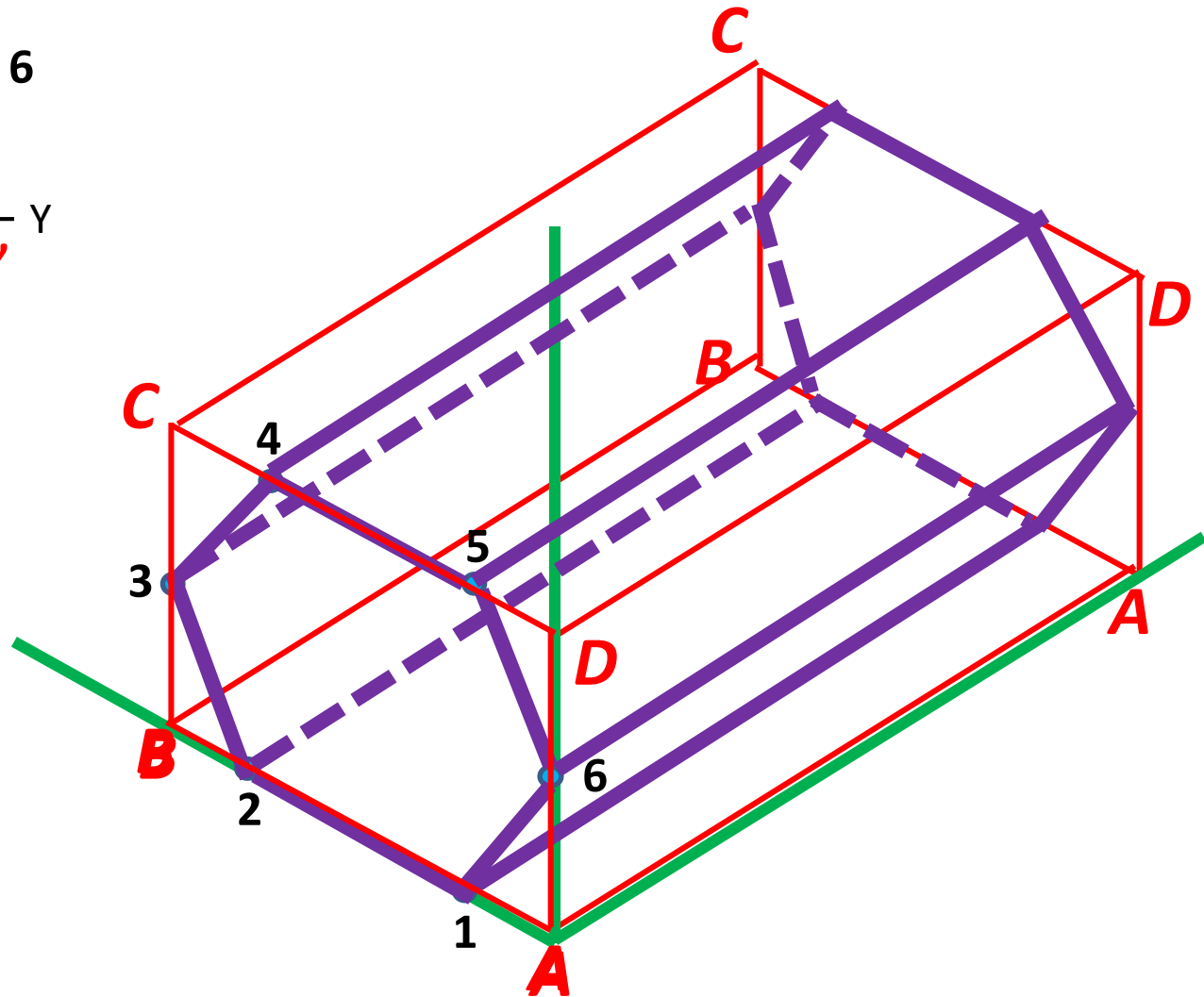
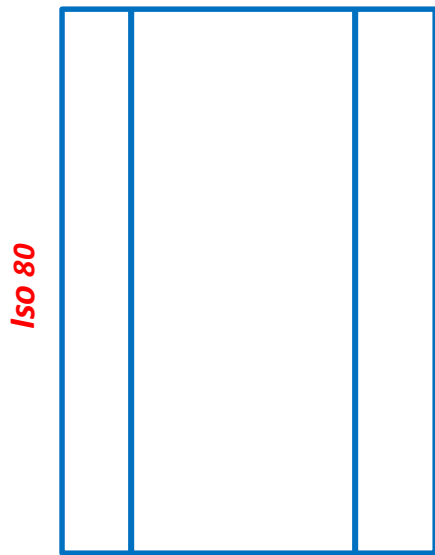
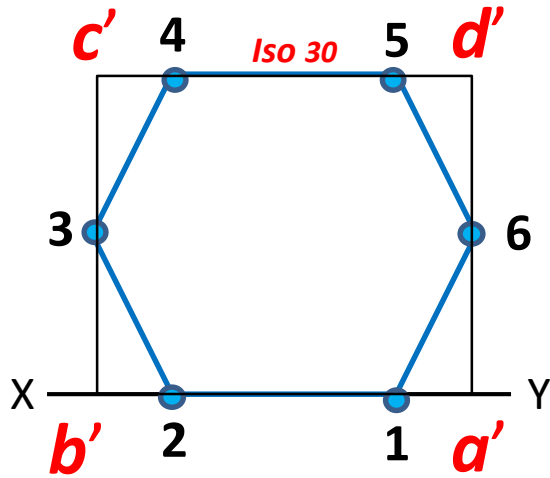

ISO(11). CYLINDER

Isometric Projection

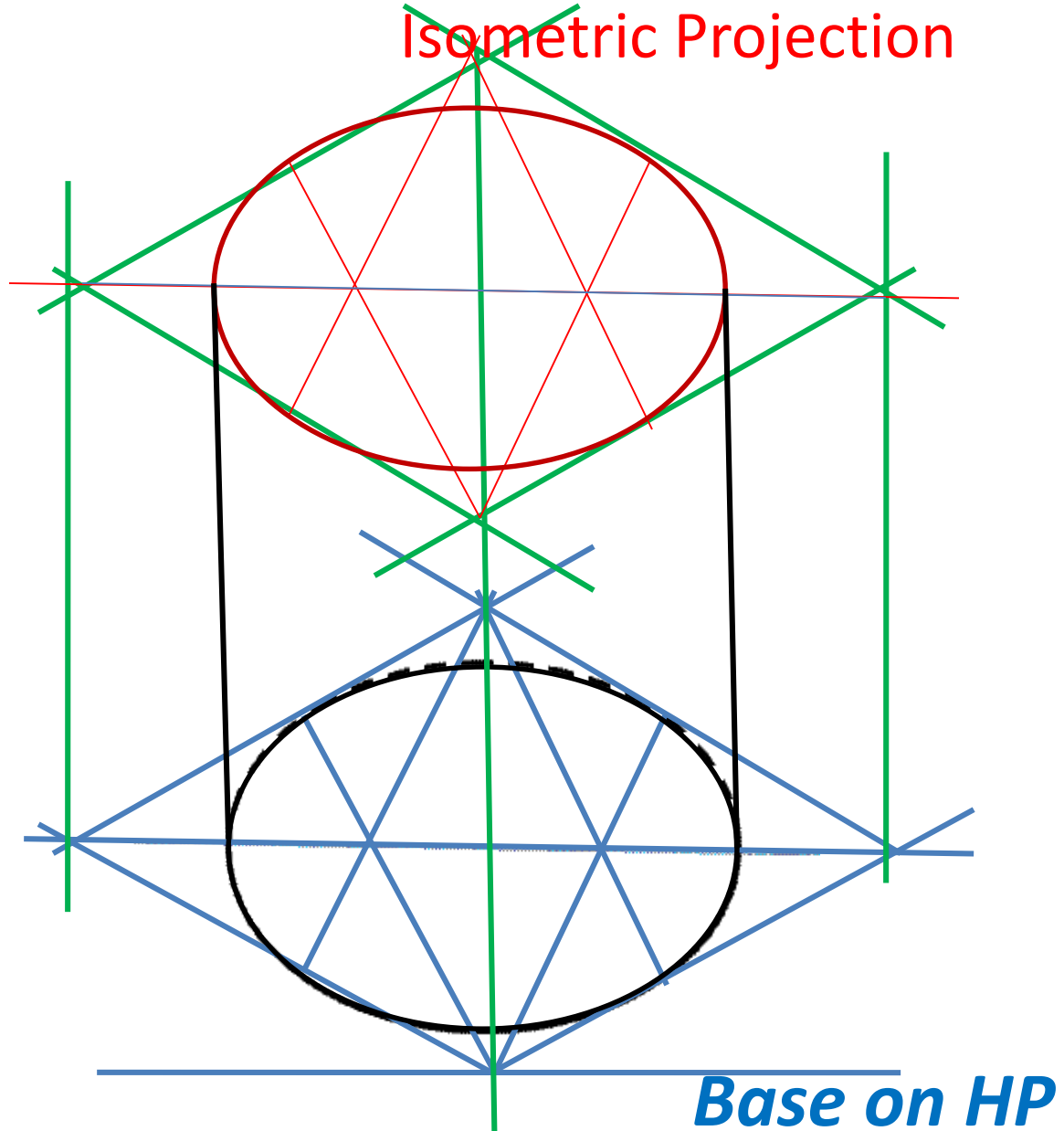
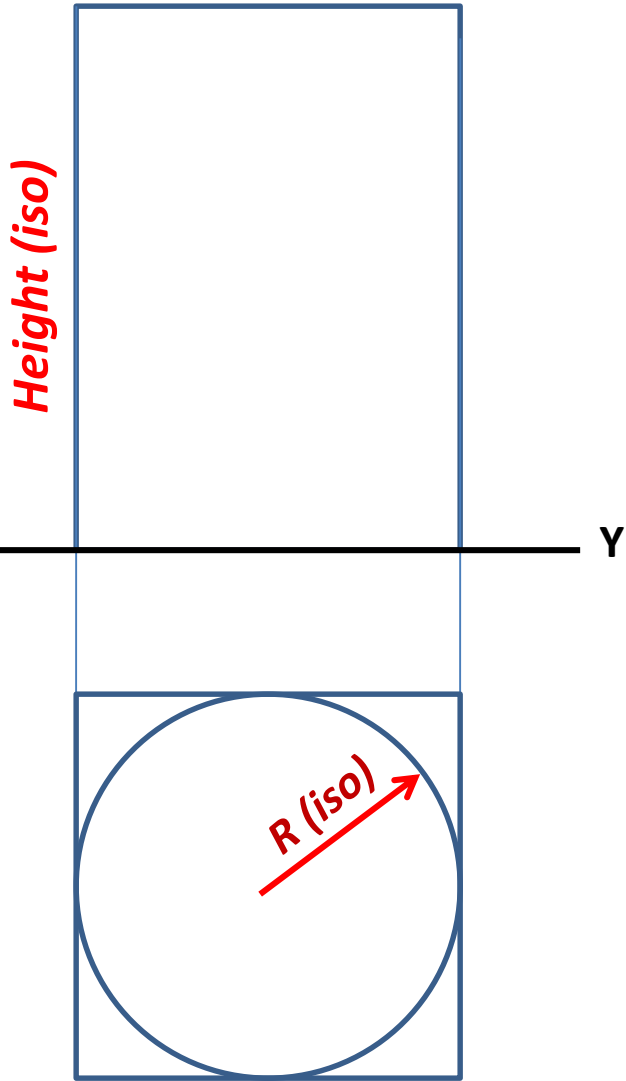

ISO(12). CONE

Isometric Projection

Base on HP

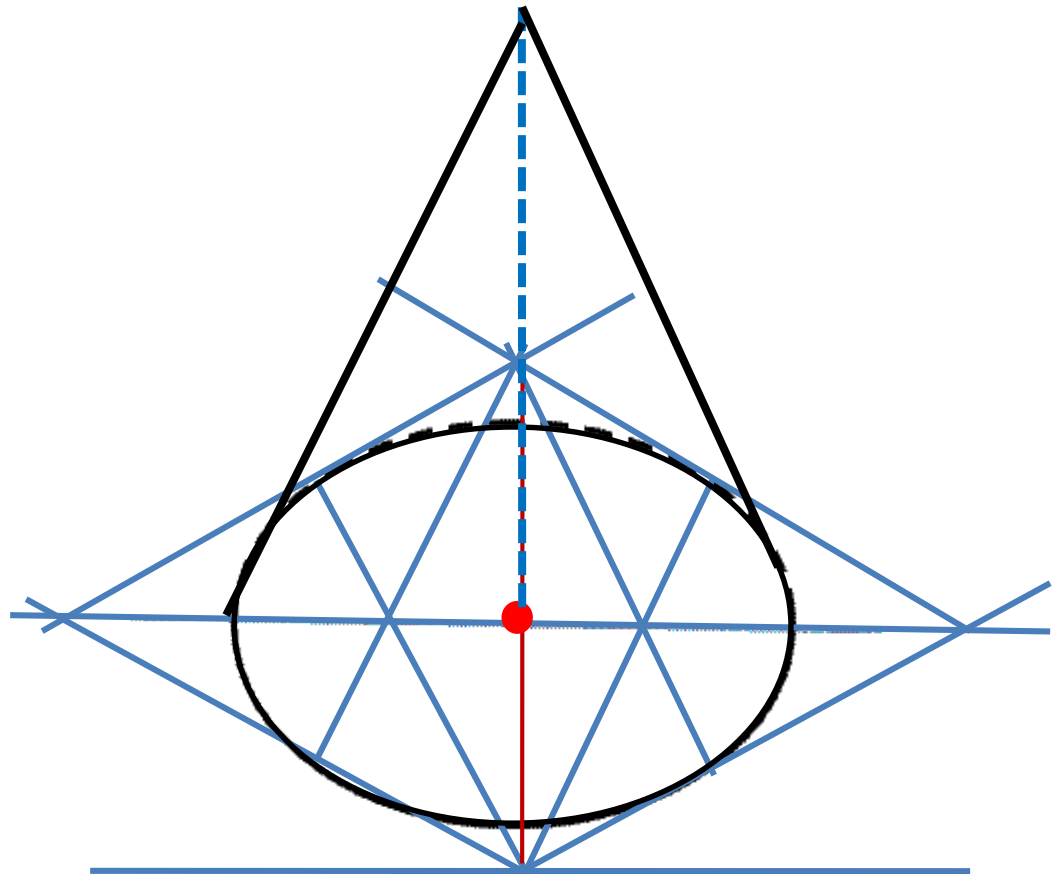
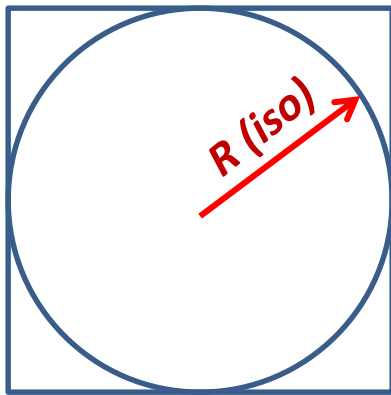
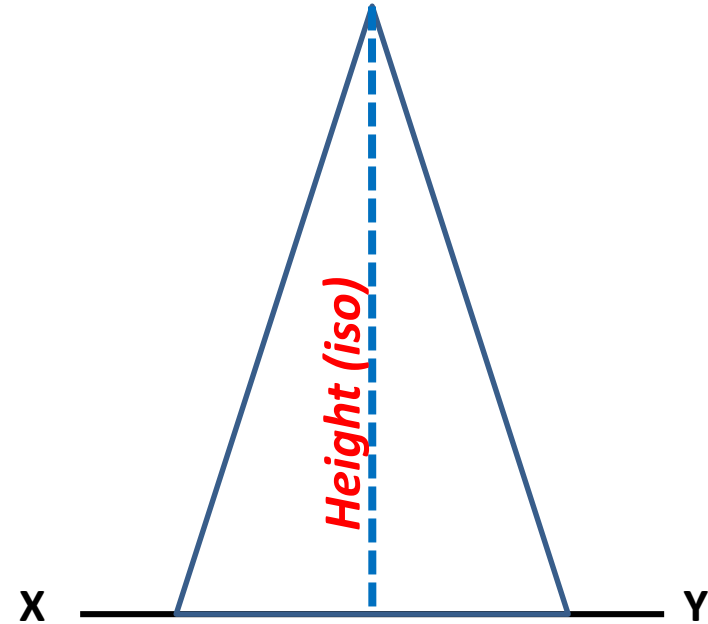

ISO(14). Frustum of Square pyramid Isometric Projection

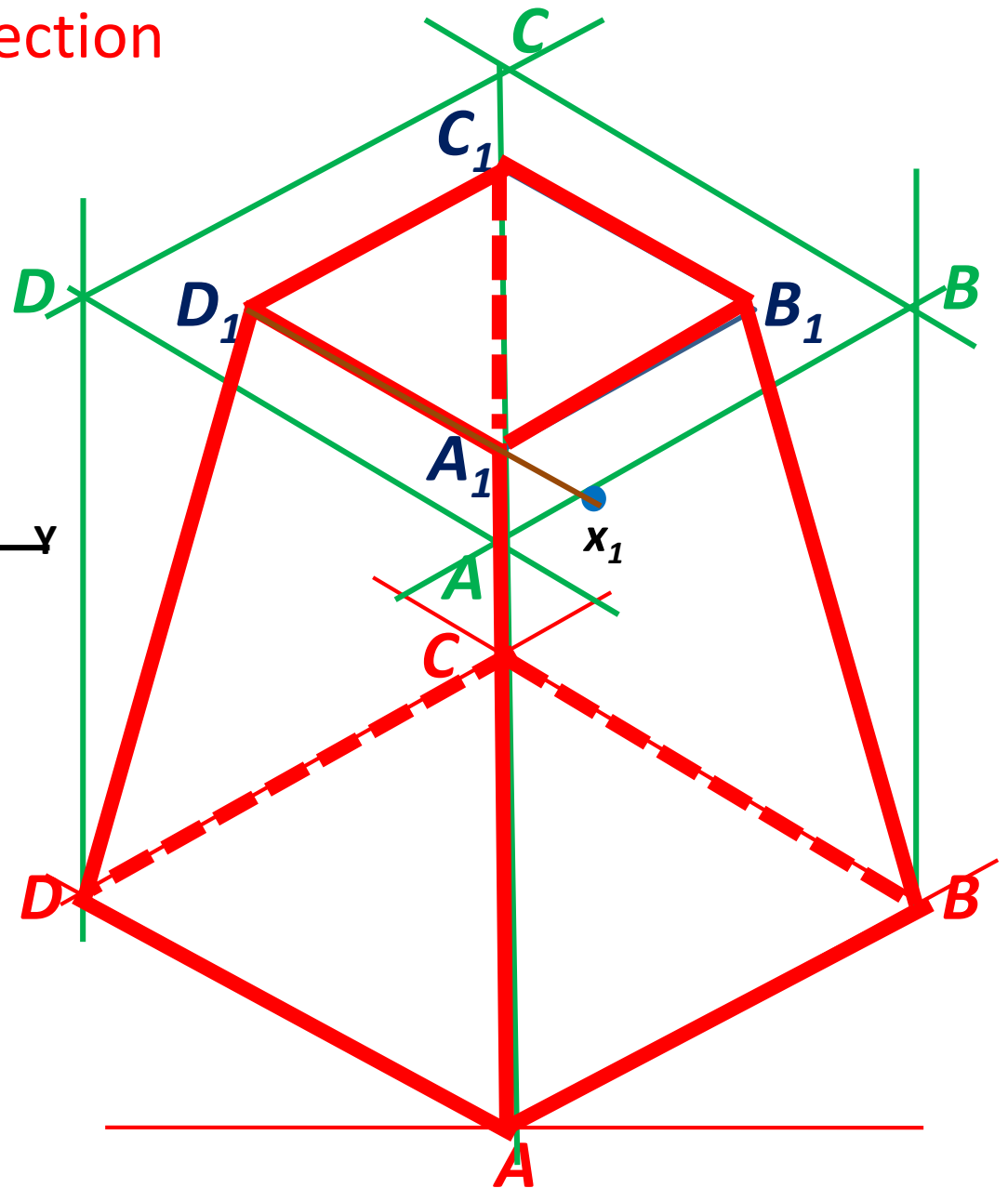
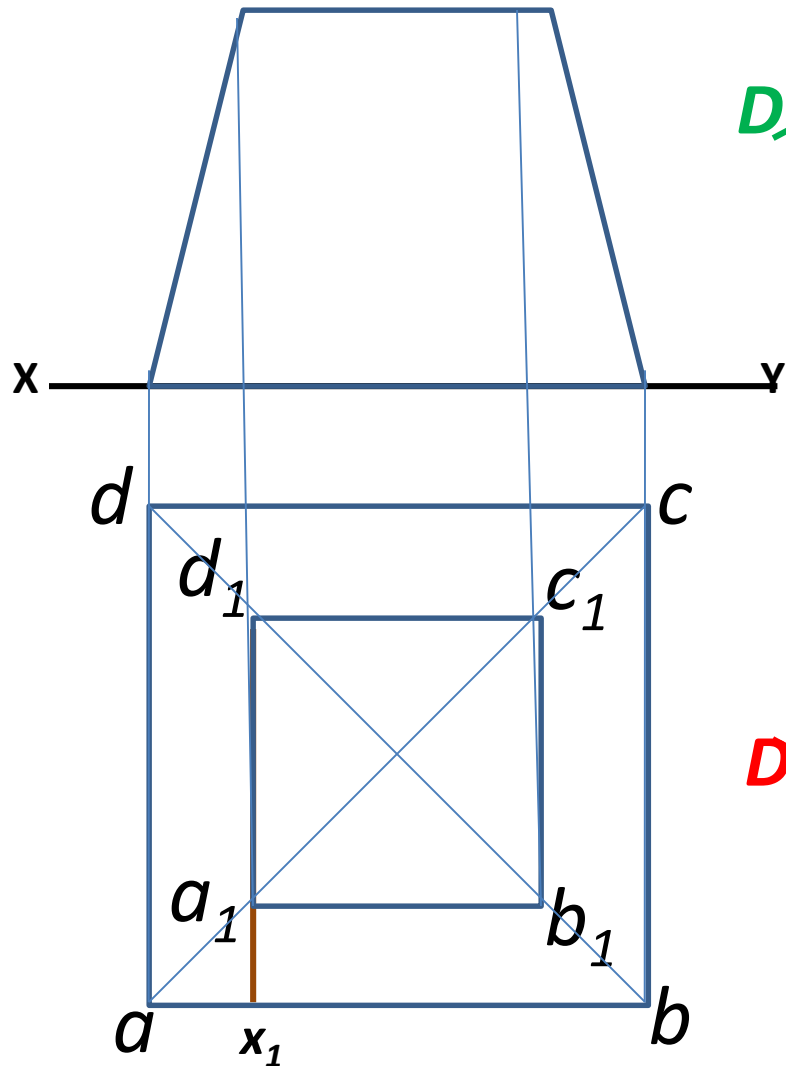

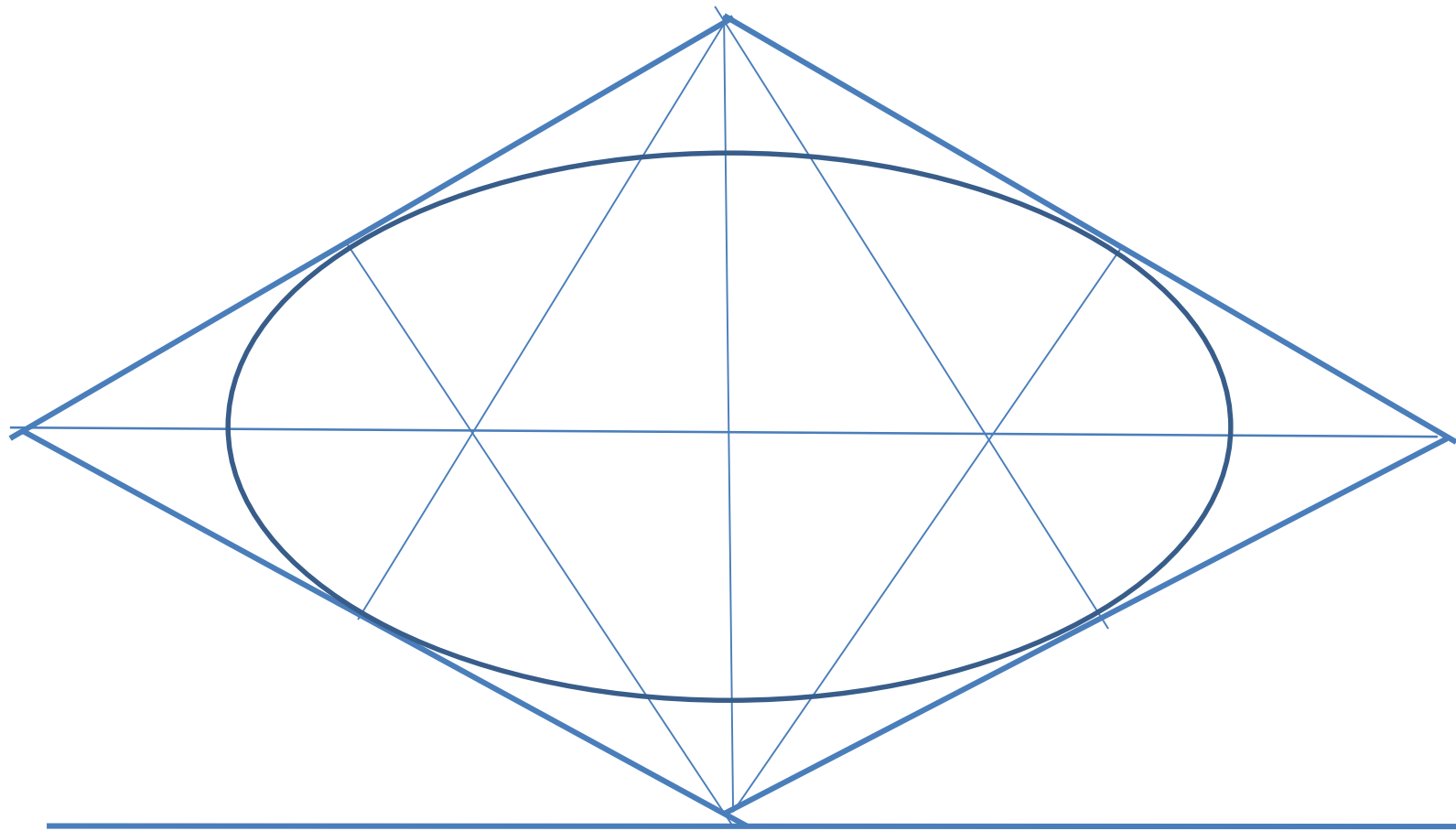

ISO(15). **Frustum of Cone**
Isometric Projection

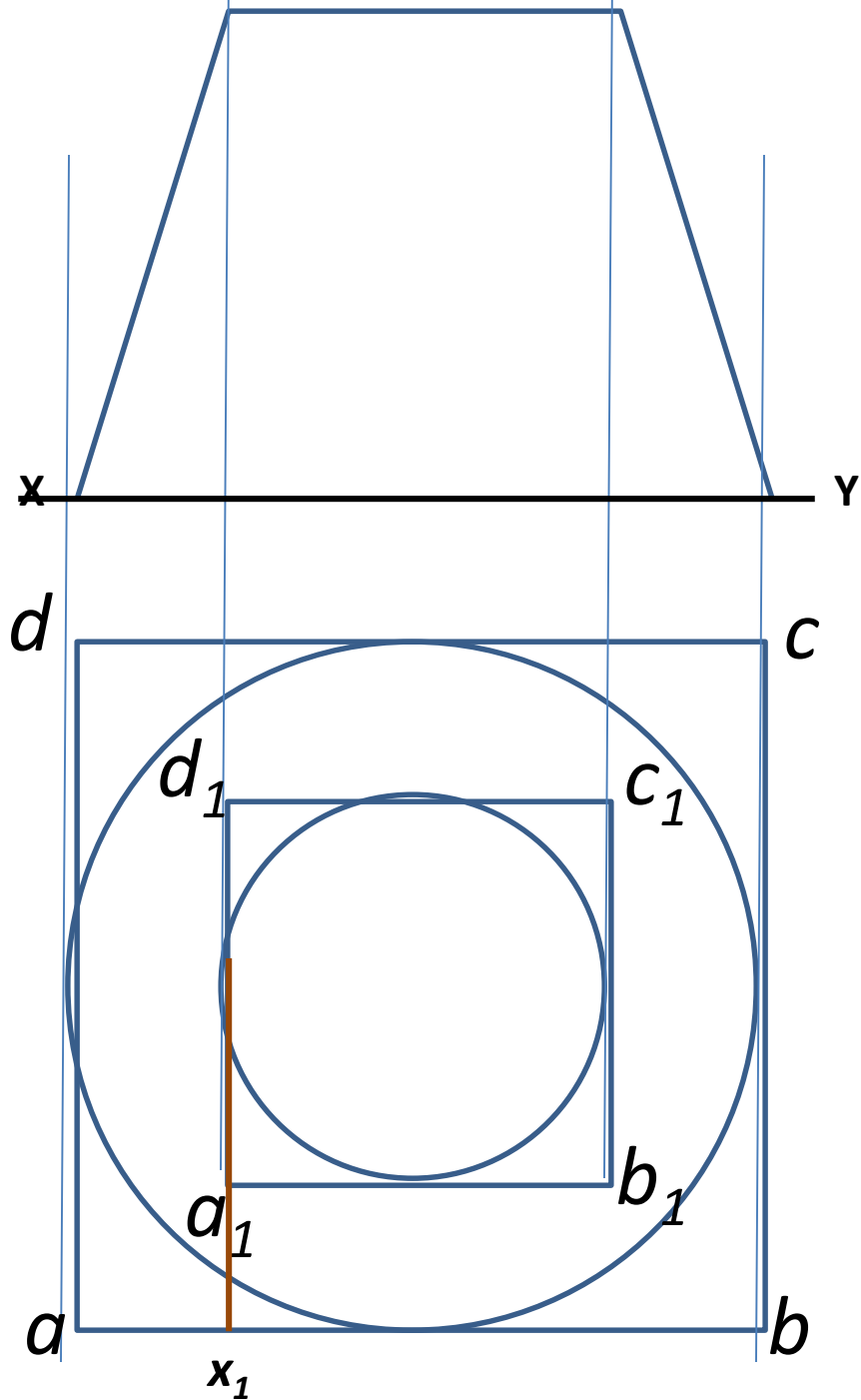

ISO(16).
CYLINDER
Isometric Projection

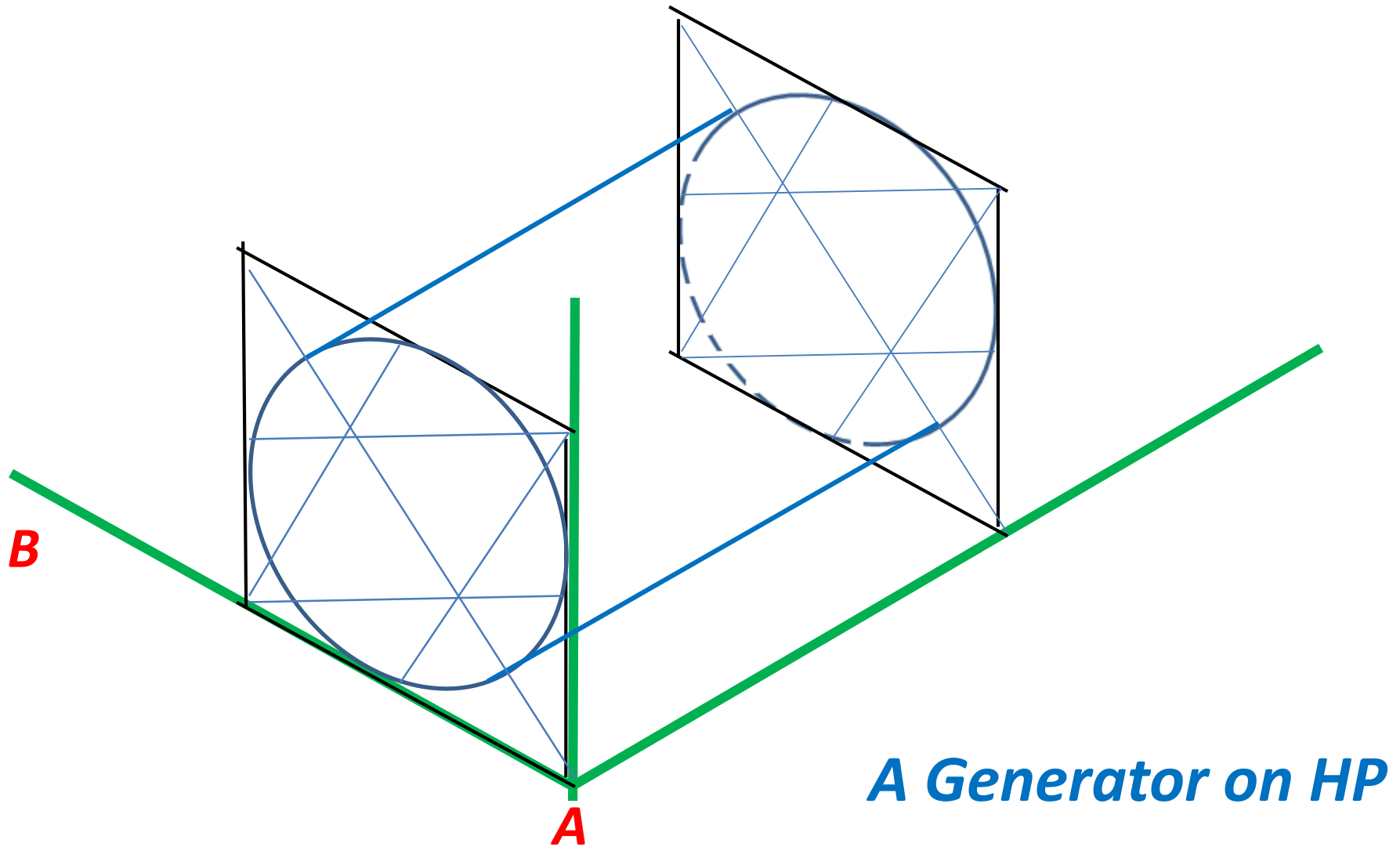

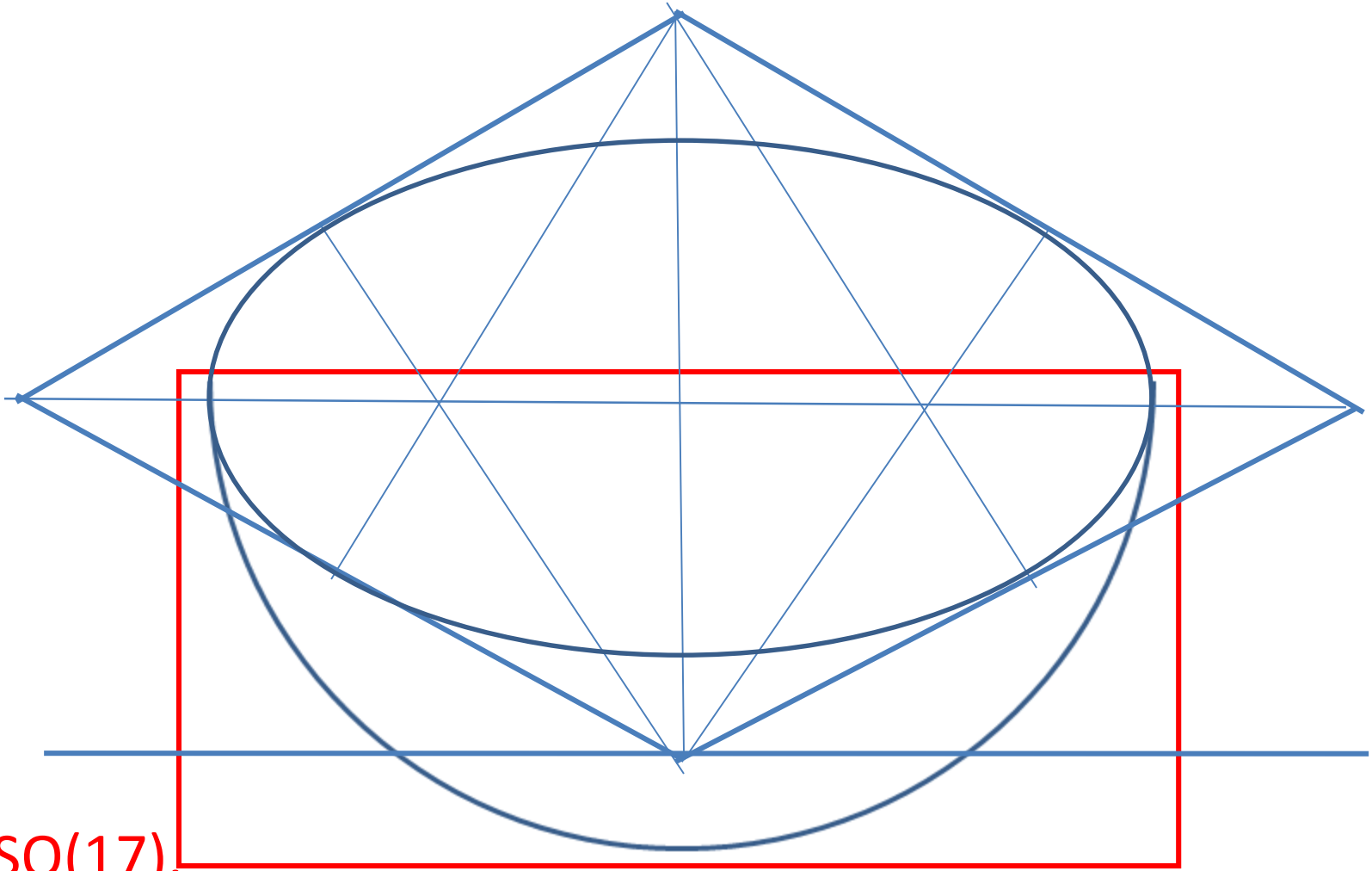

ISO(17).

HEMISPHERE (flat face up)

Isometric Projection

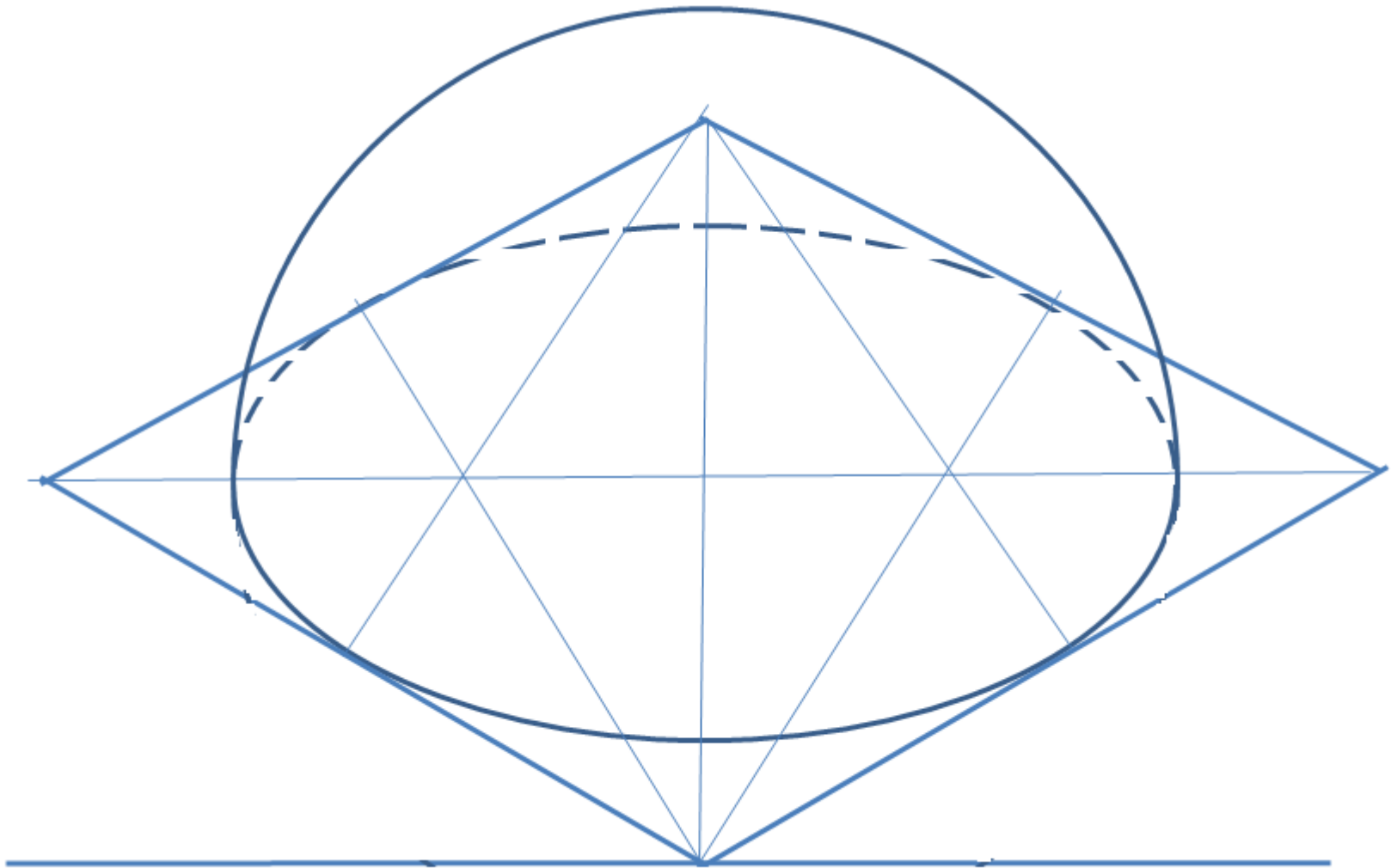

ISO(17).
HEMISPHERE (flat face down)
Isometric Projection

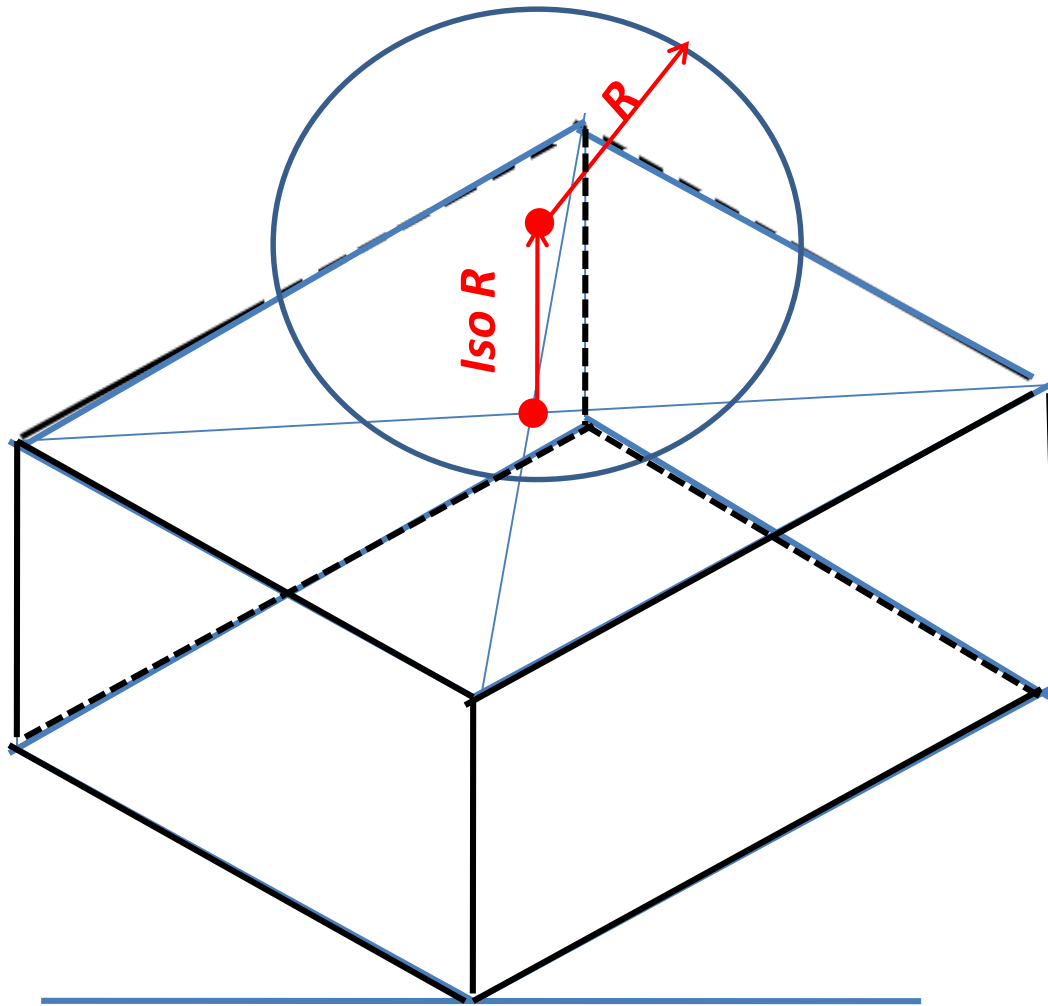

**ISO(18). RECTANGULAR SLAB & SPHERE ON TOP
Isometric Projection**

ISO(19).
Cube & Square Pyramid On Top
 Isometric Projection

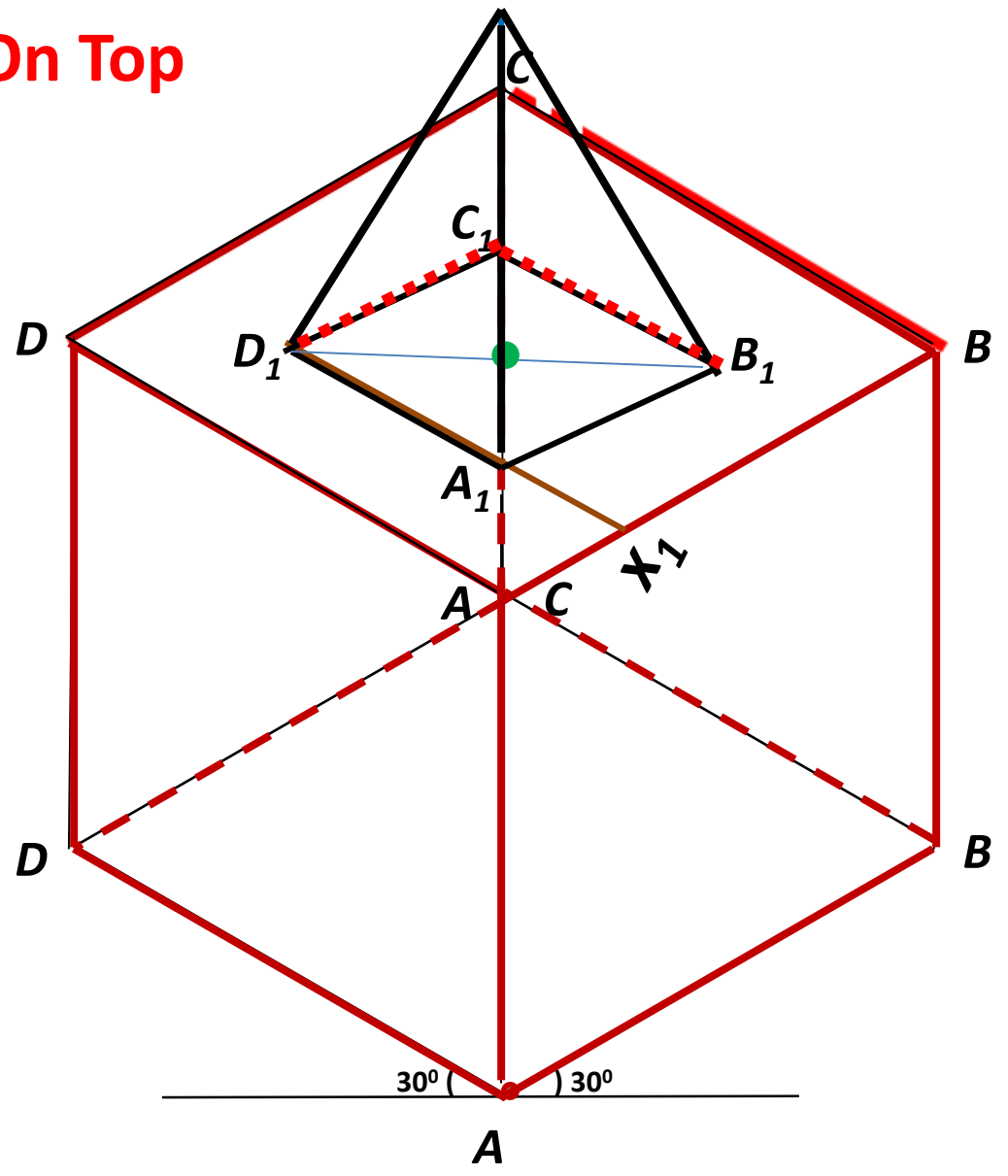
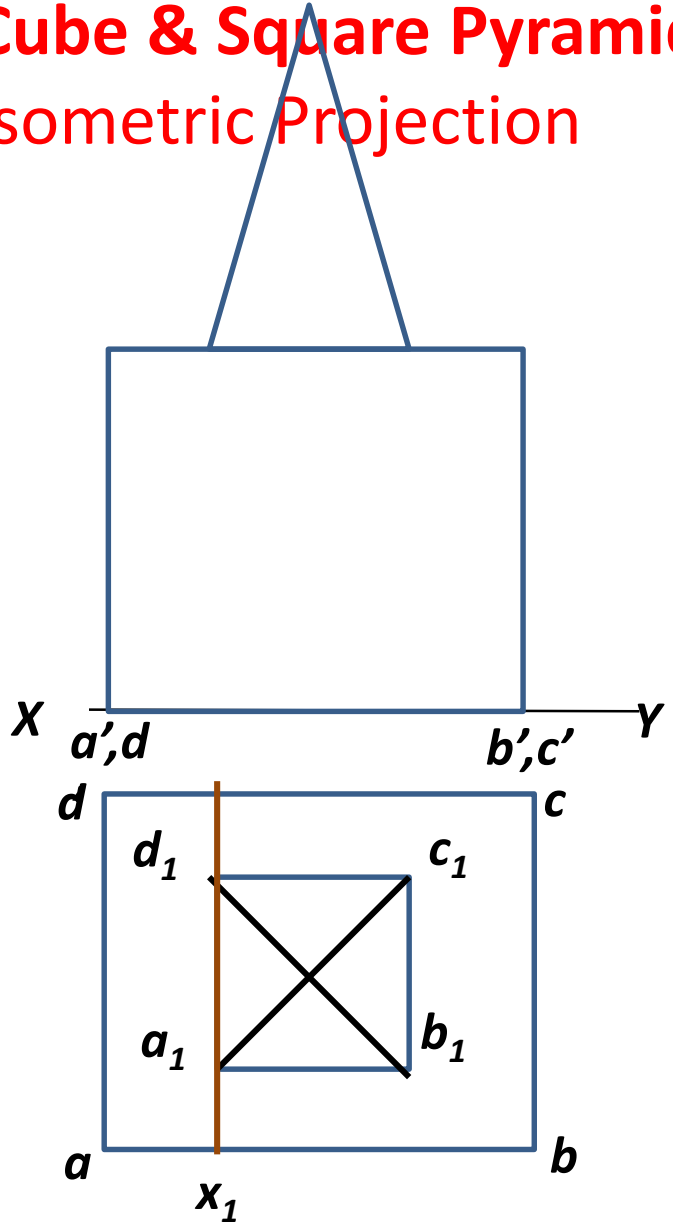

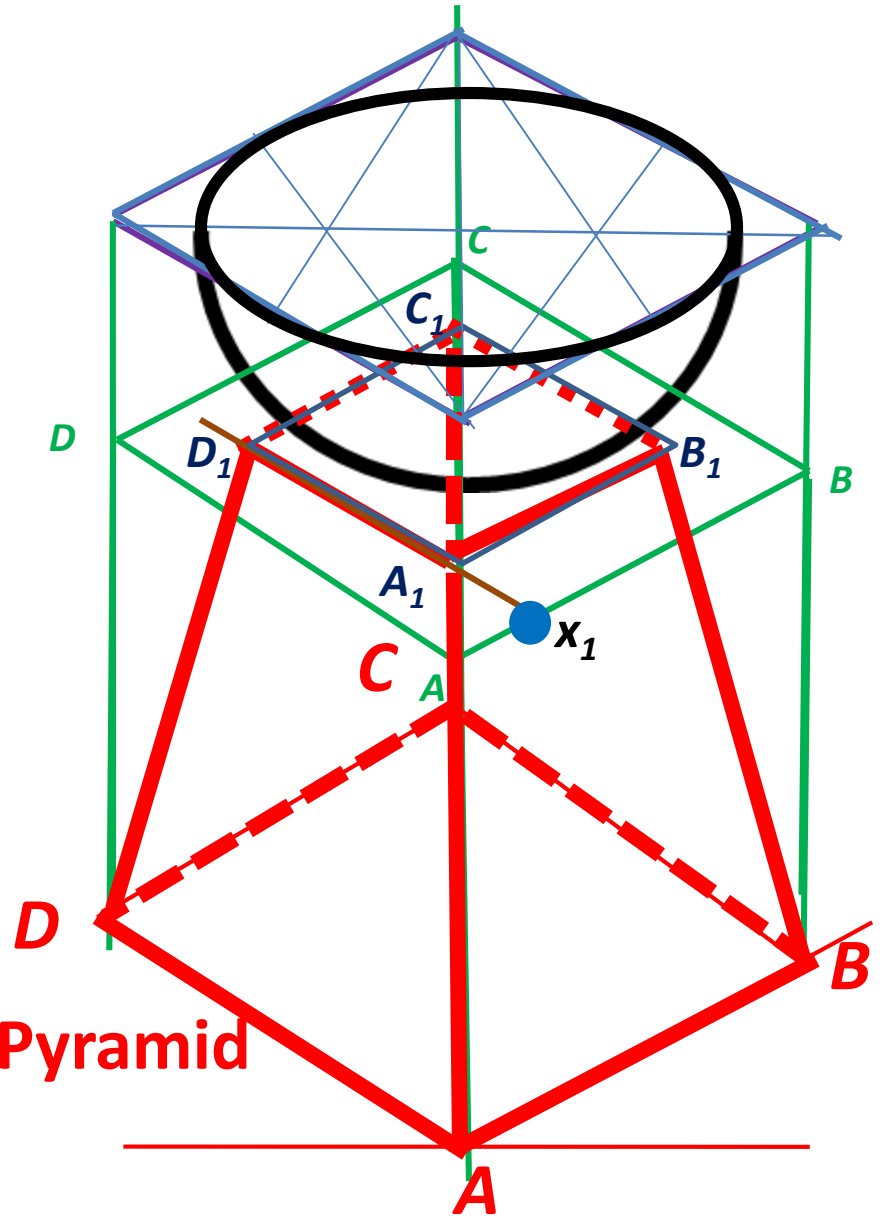
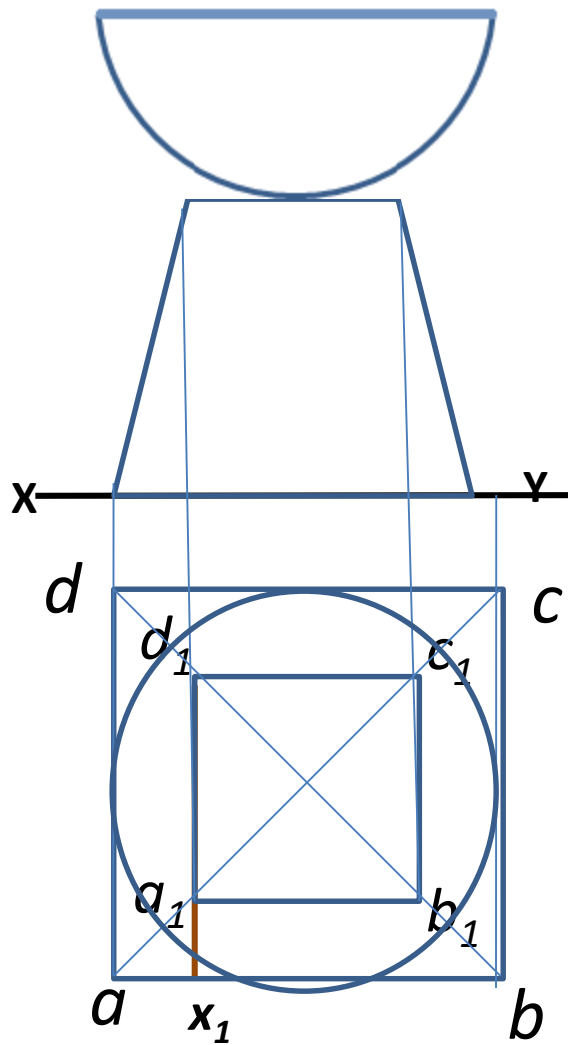

**ISO(20). Frustum of Square Pyramid
& Hemisphere on Top
Isometric Projection**

ISO(21). Small Sphere on Top of a Bigger Sphere

Isometric Projection

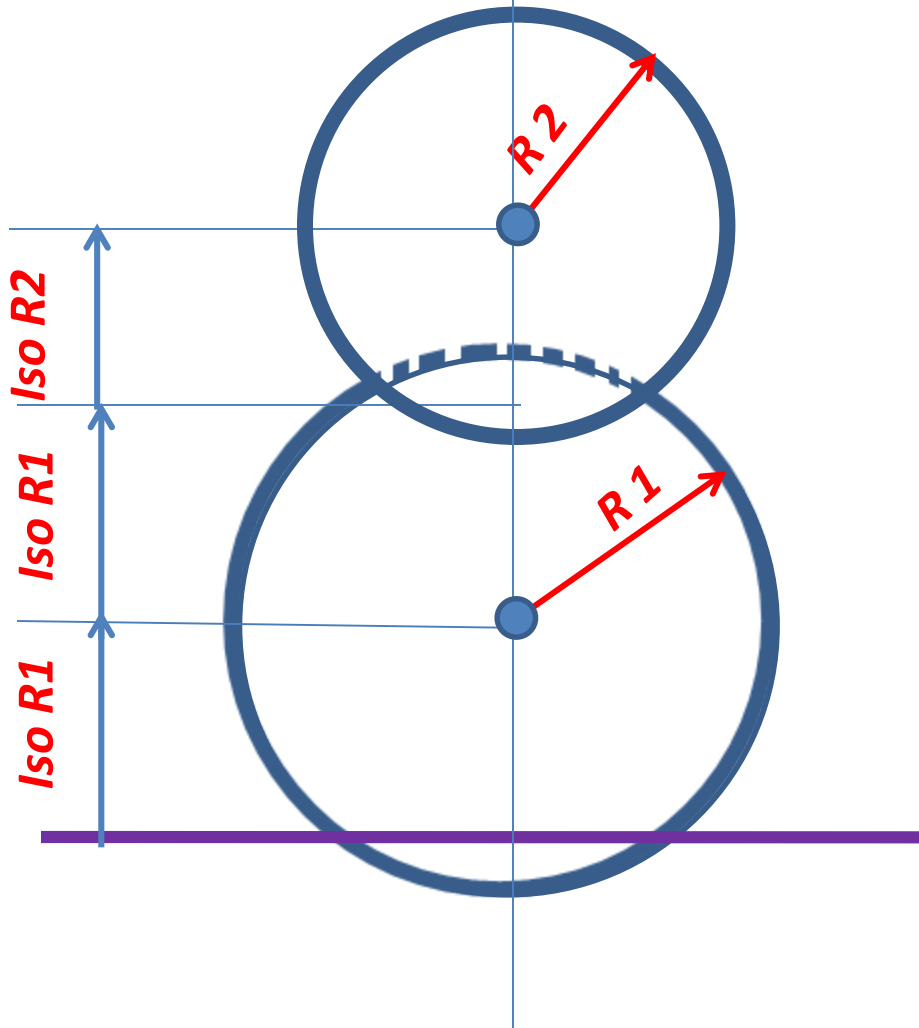

ISO(22). TRUCATED SQUARE PYRAMID

Isometric View

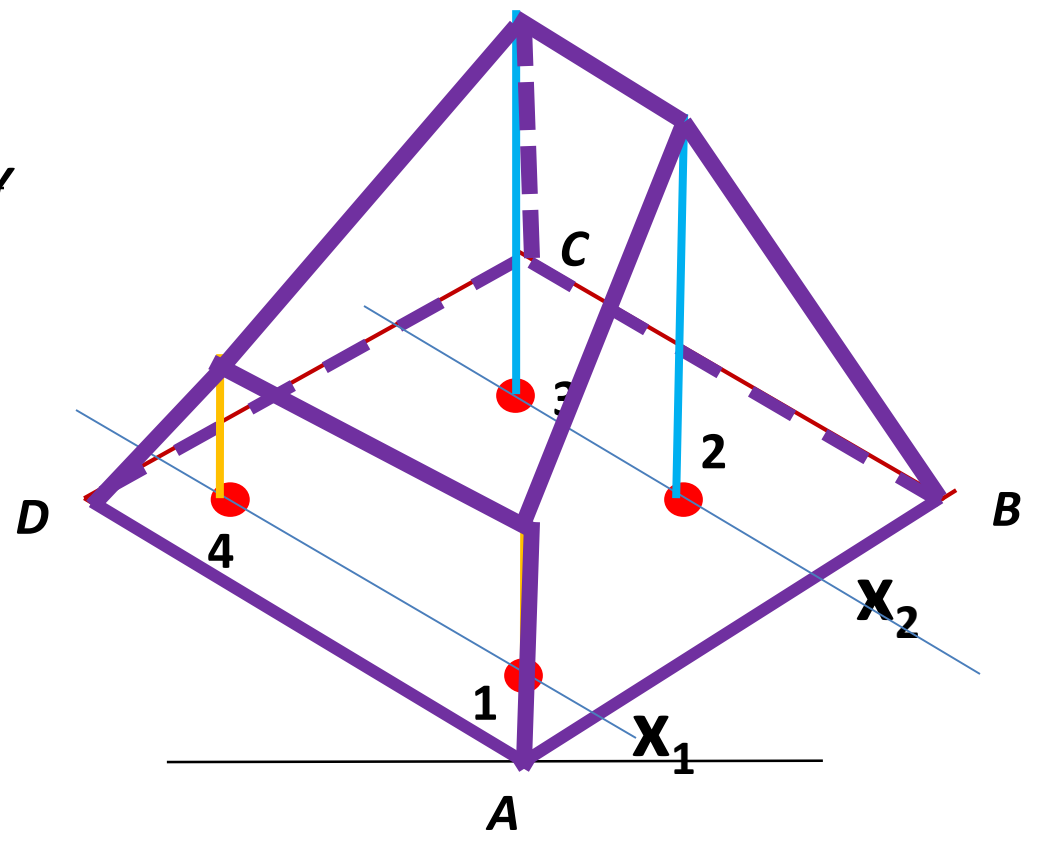
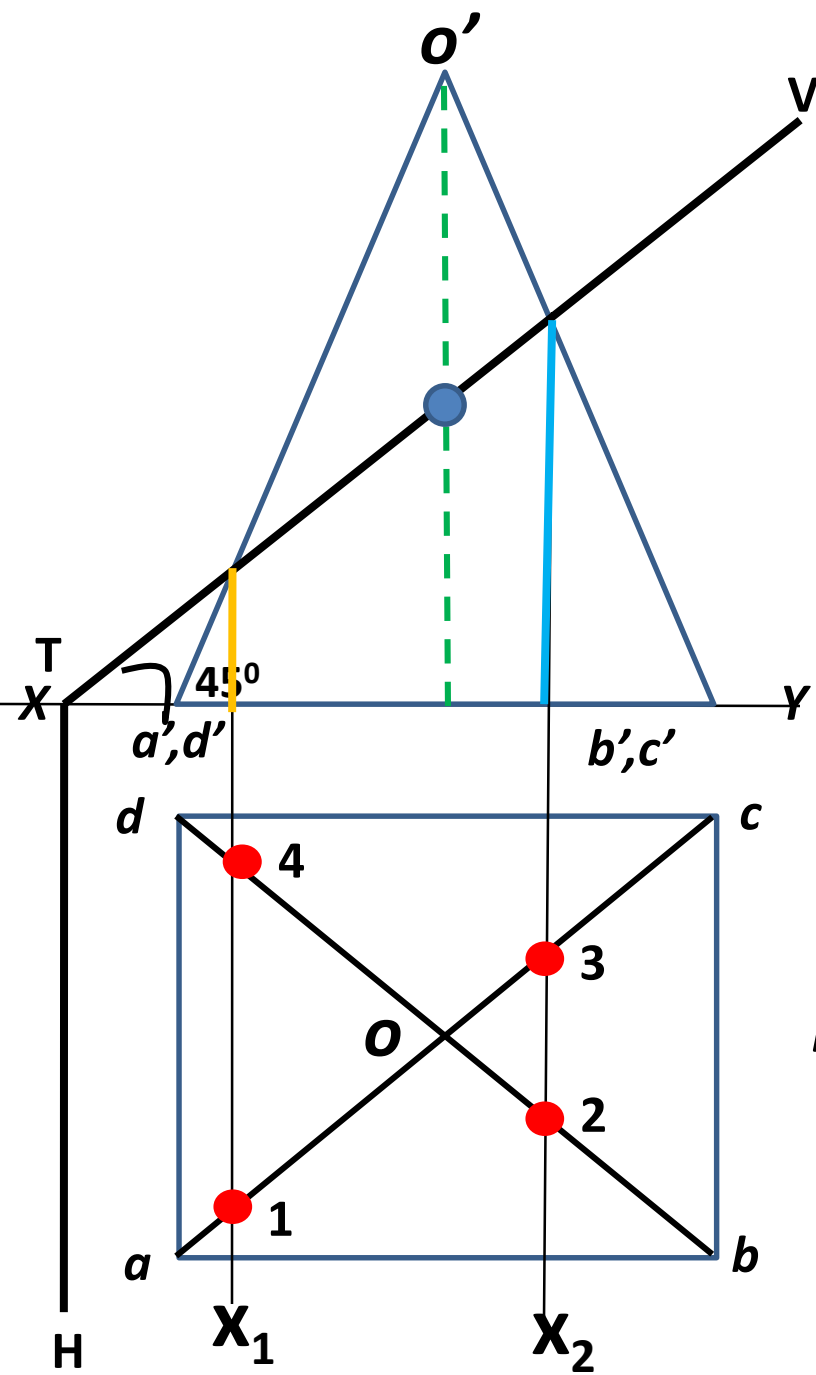

ISO(22). TRUCATED SQUARE PYRAMID

Isometric View

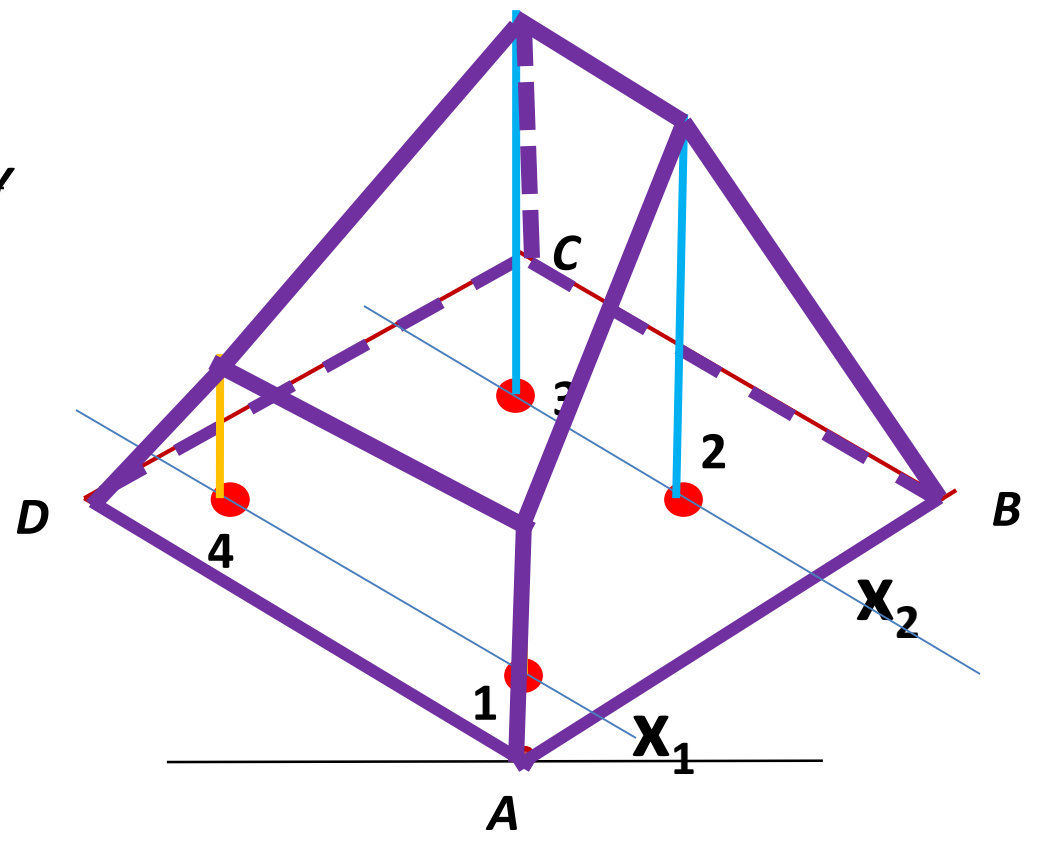
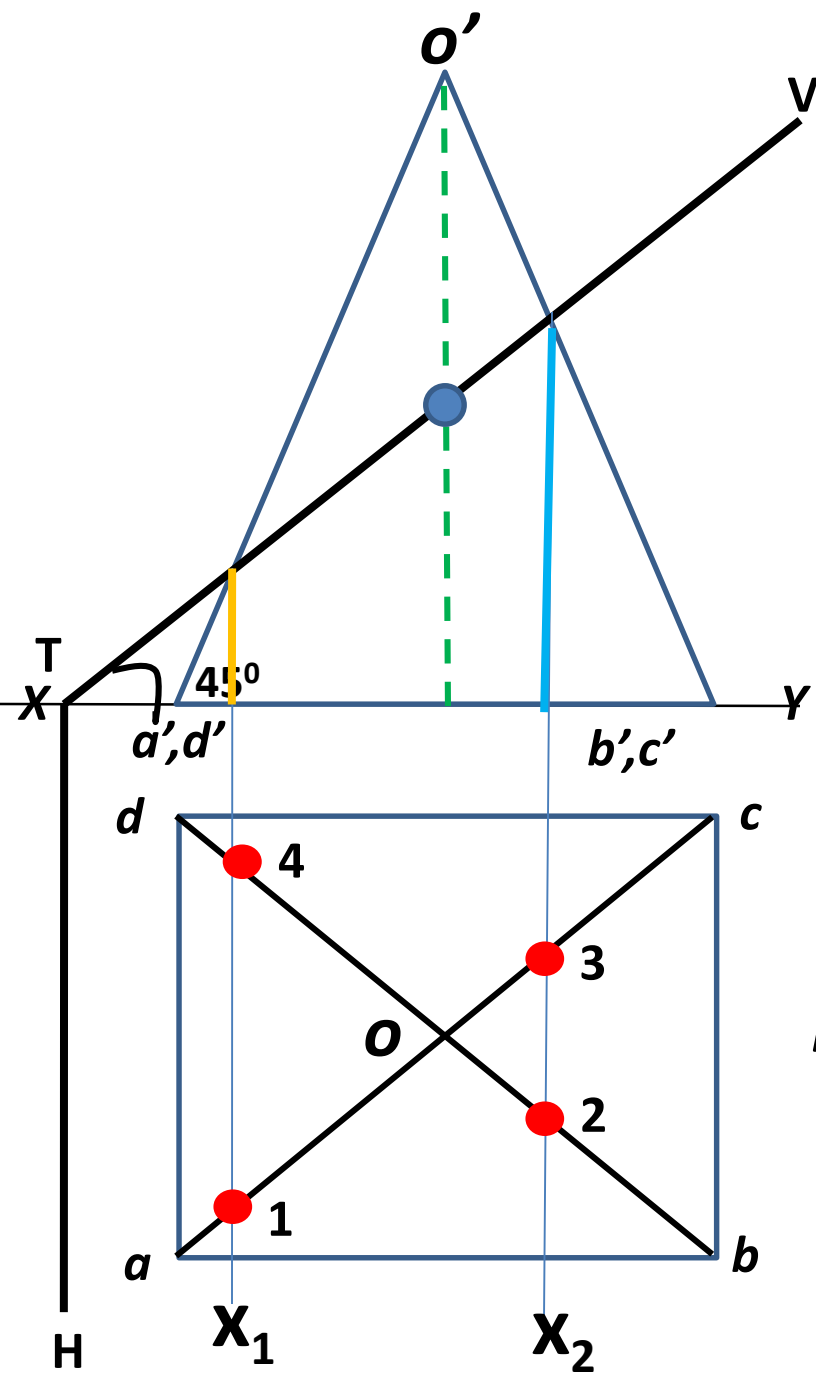

ISO(23). TRUCATED CONE

Isometric Projection

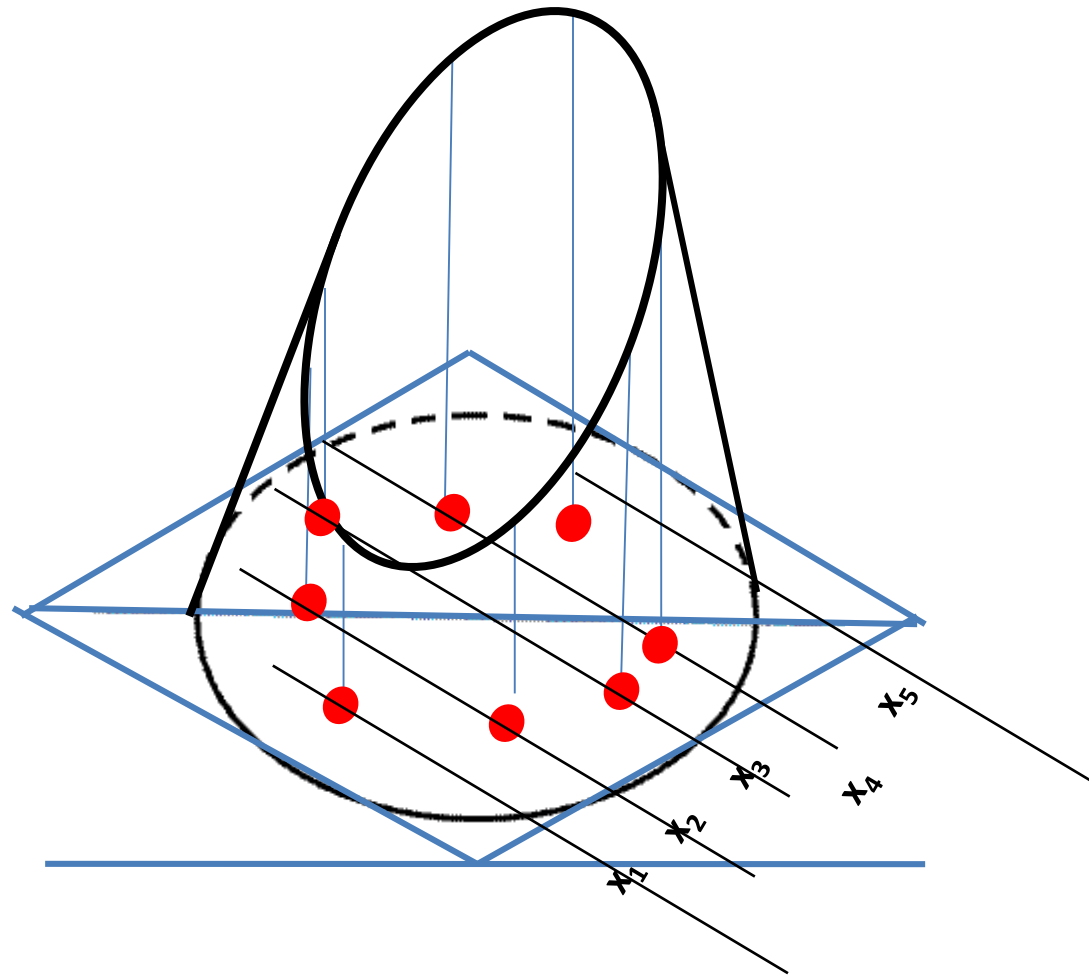
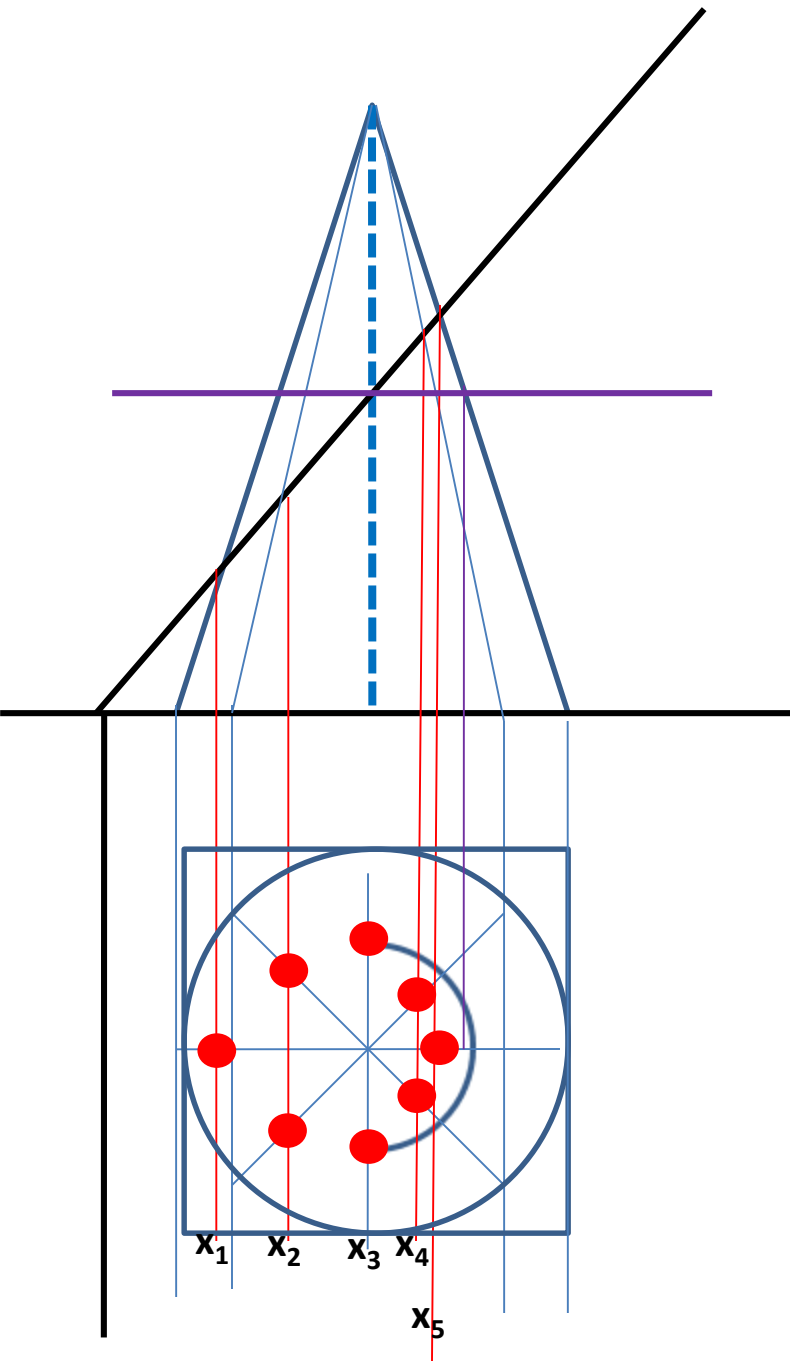

ISO(24). TRUCATED HEXAGONAL PRISM

Isometric View

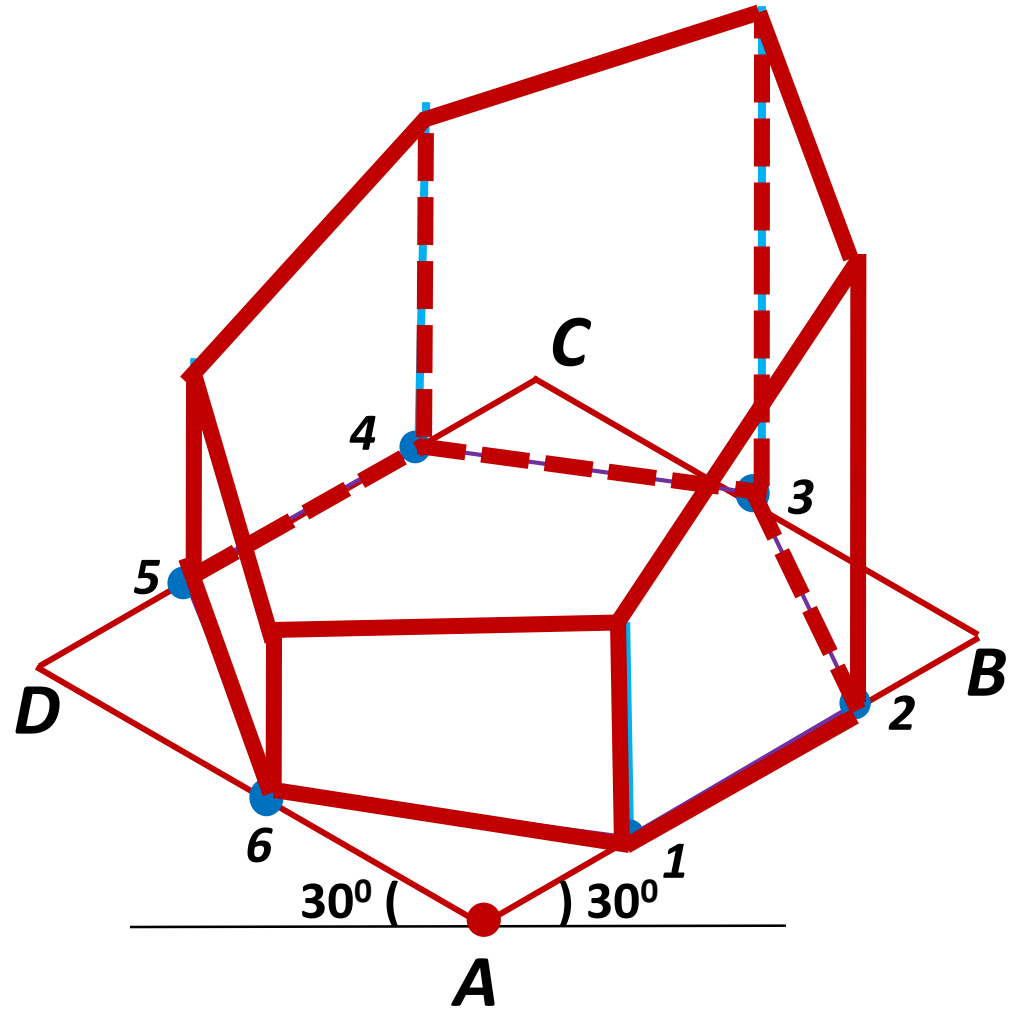
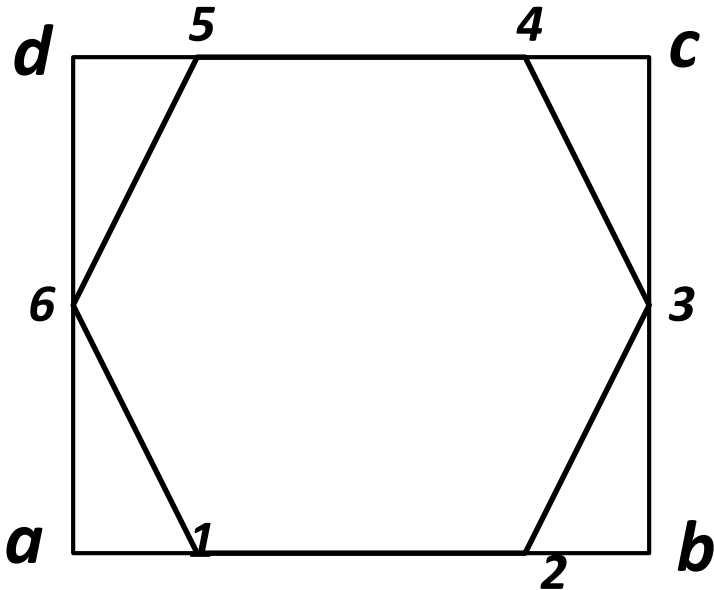
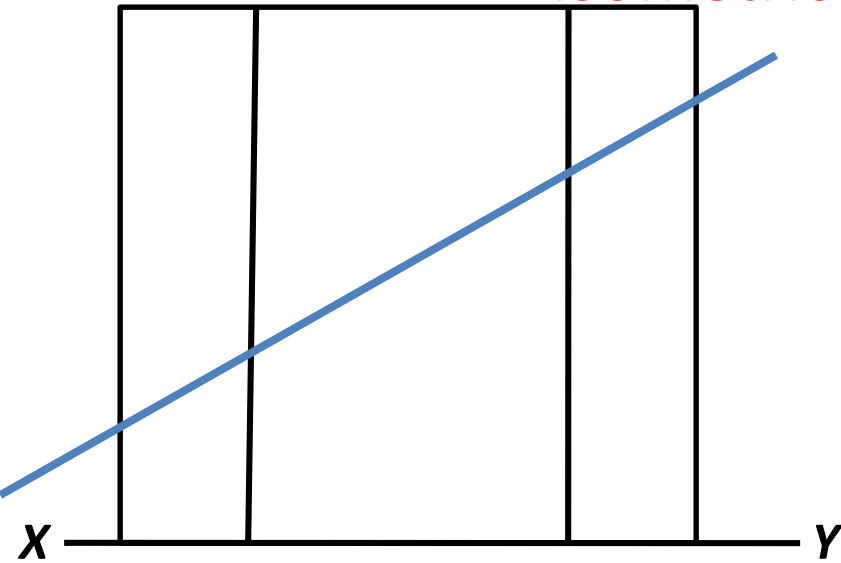

ISO(24). TRUCATED HEXAGONAL PRISM

Isometric View

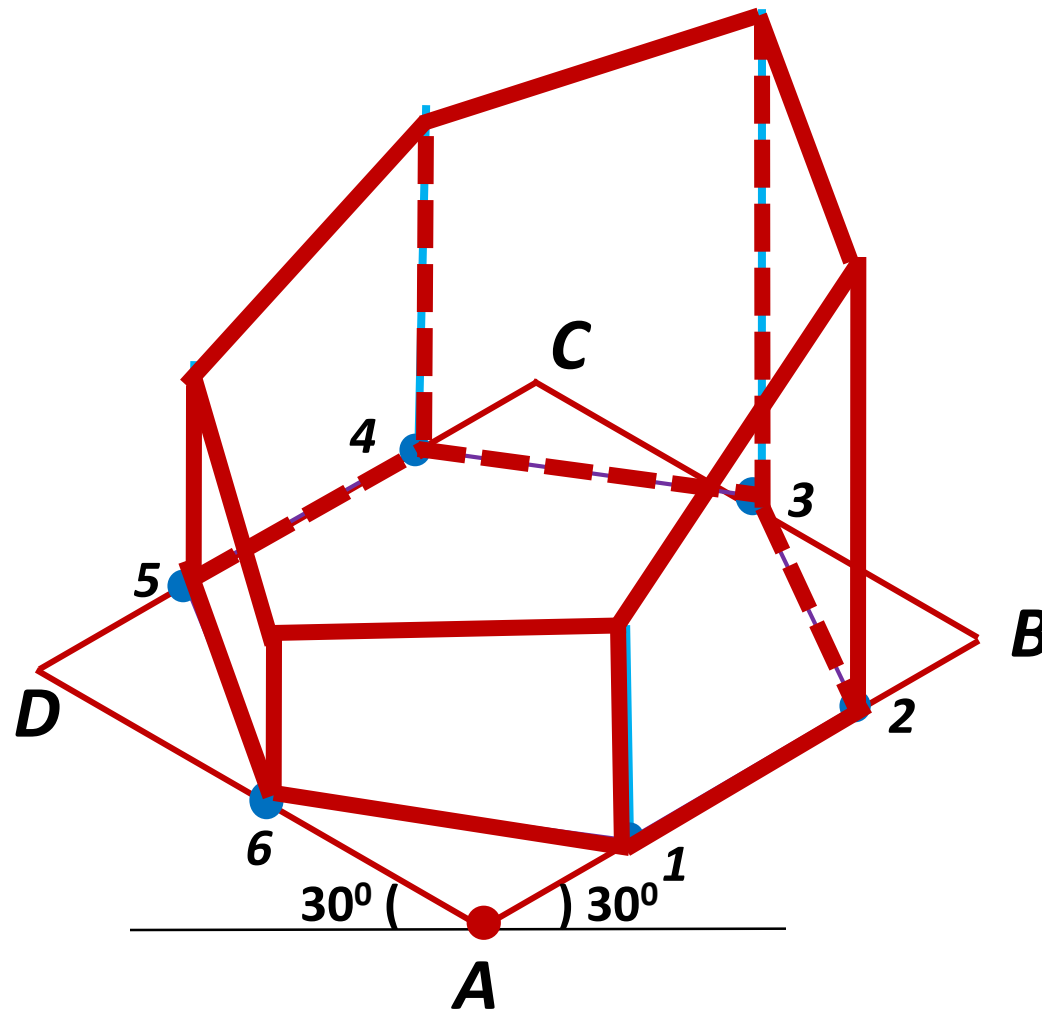
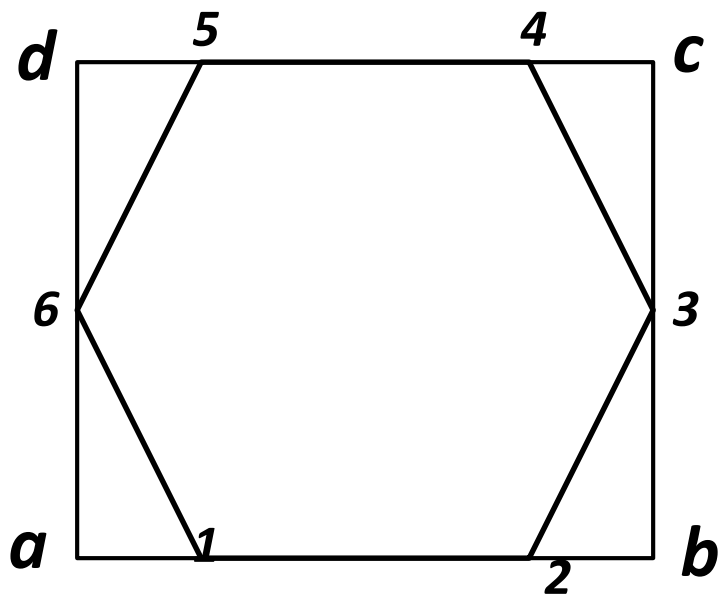
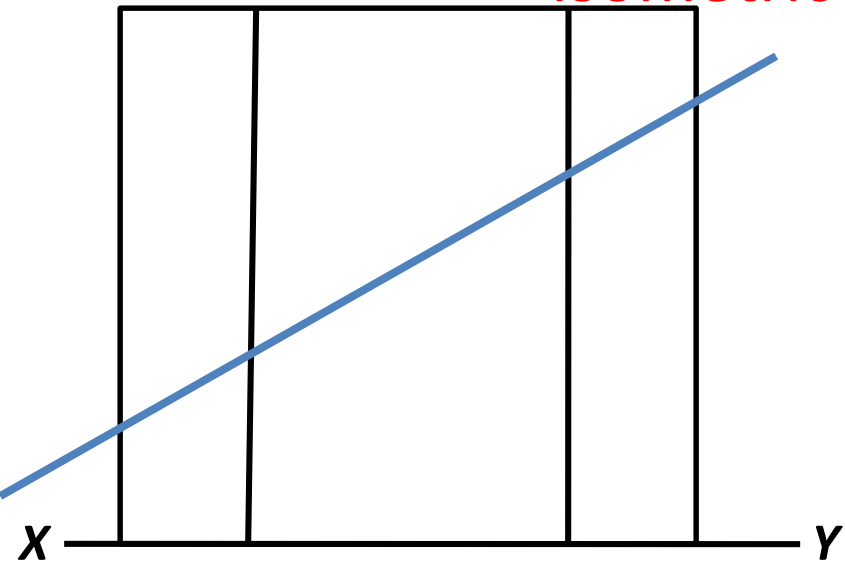

ISO(25). TRUCATED CYLINDER

Isometric Projection

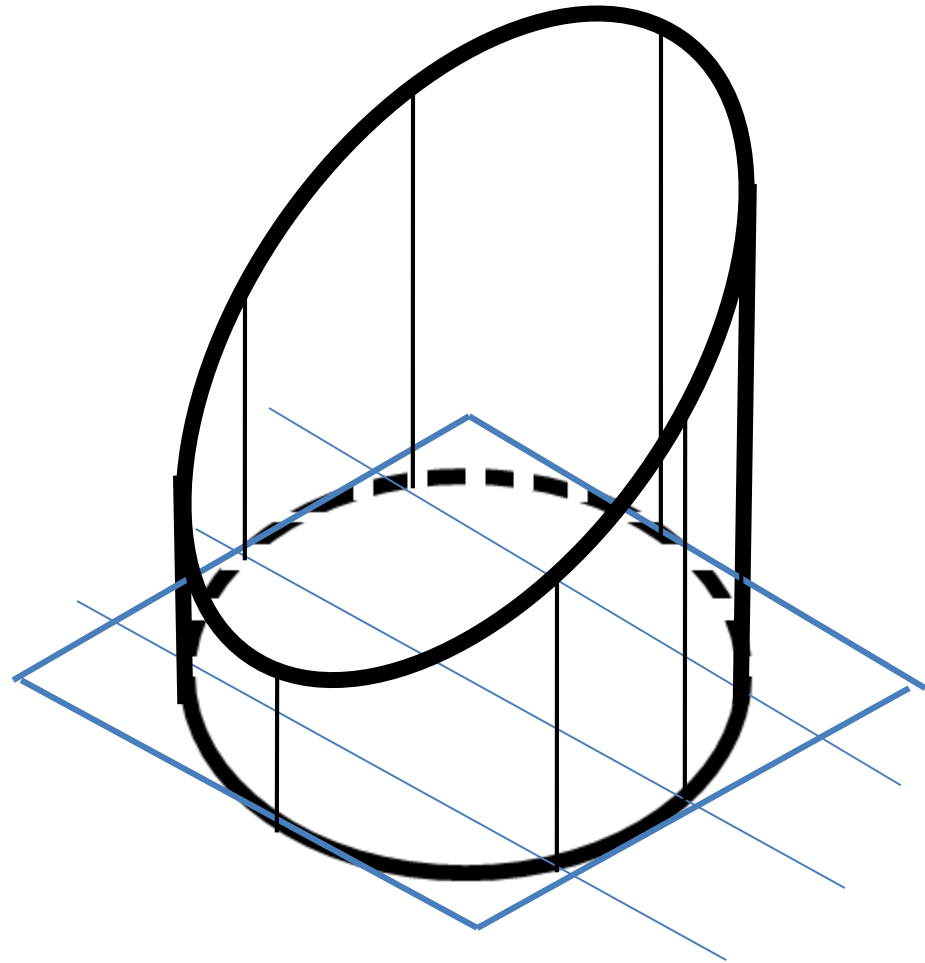
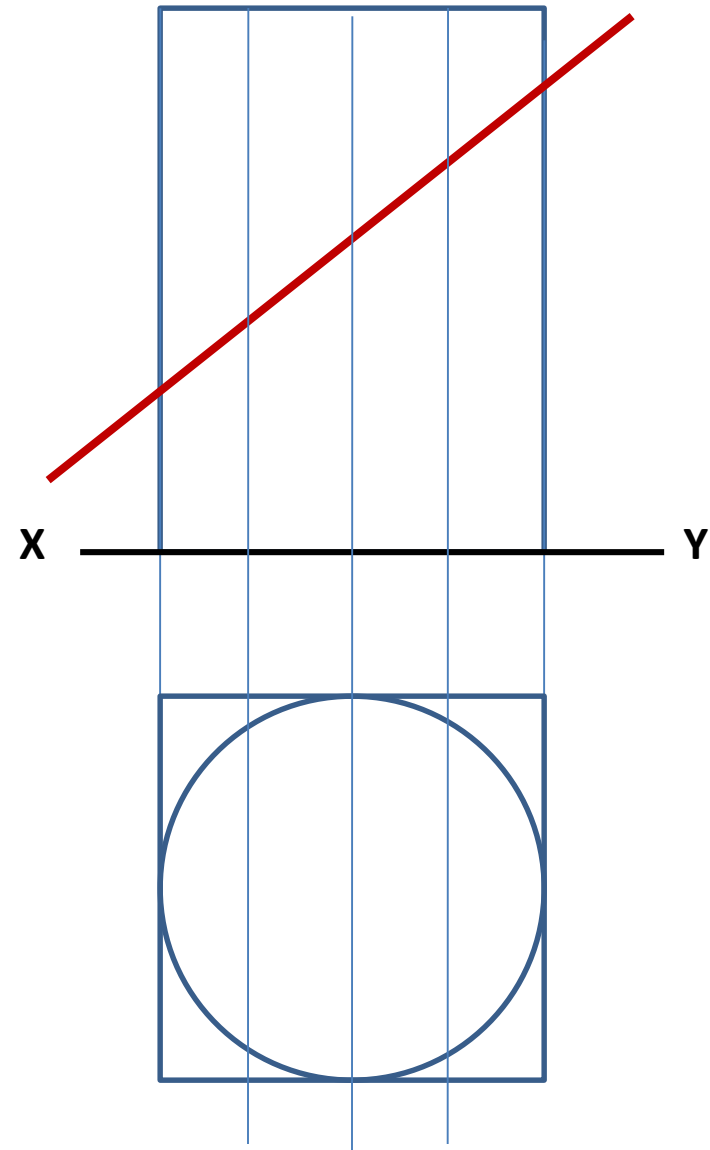

ISO(25). TRUCATED CYLINDER

Isometric Projection

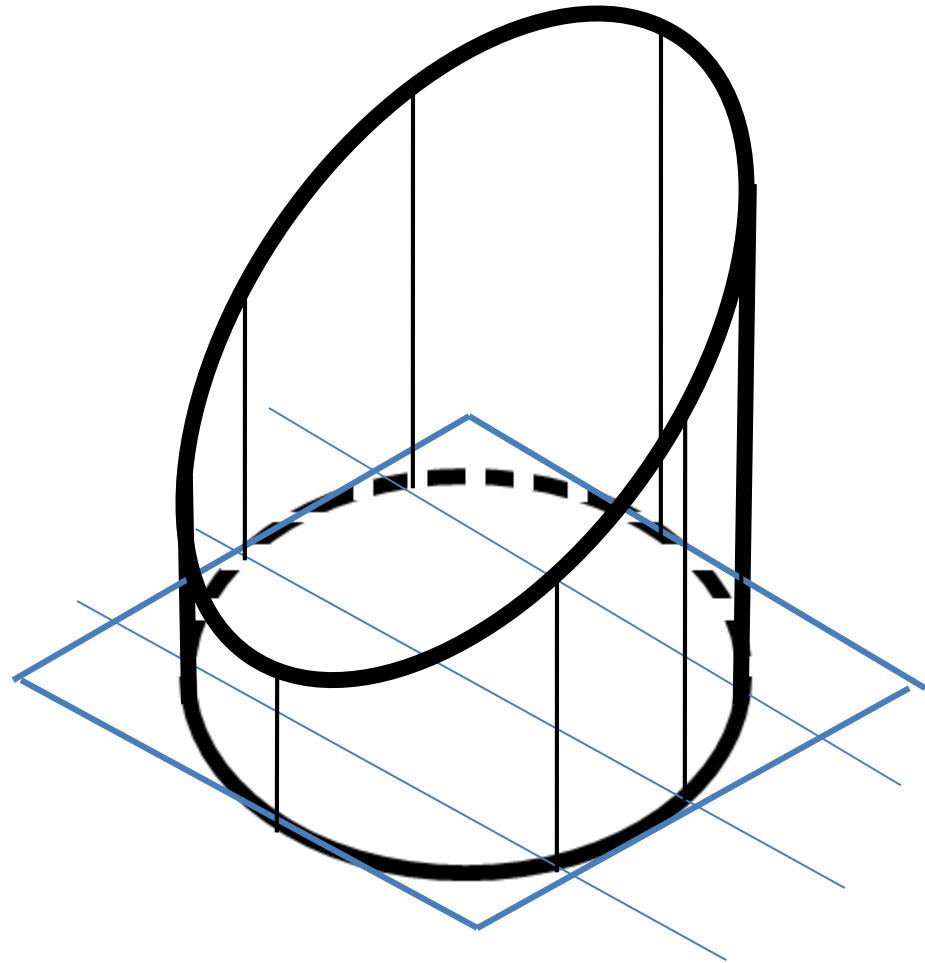
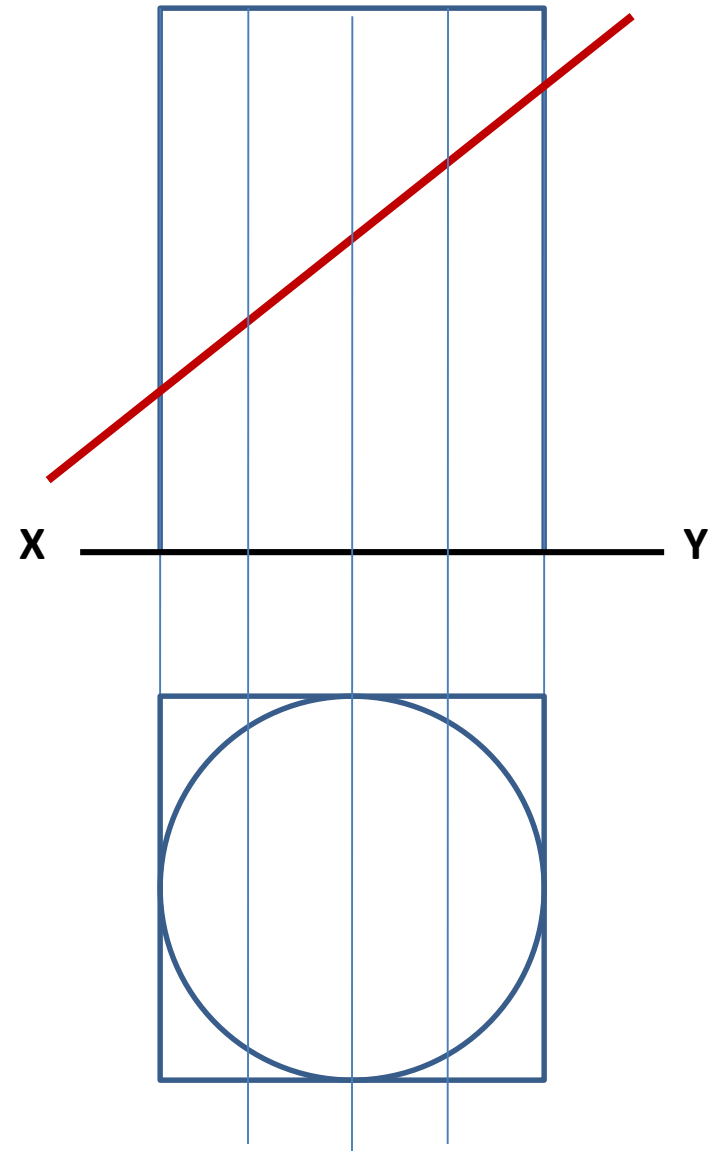

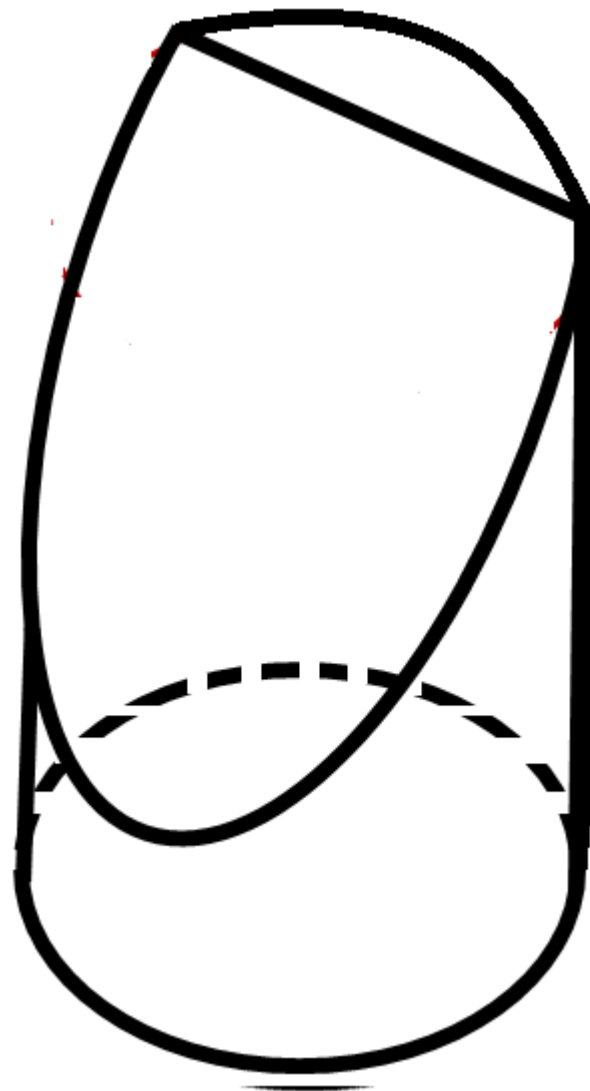
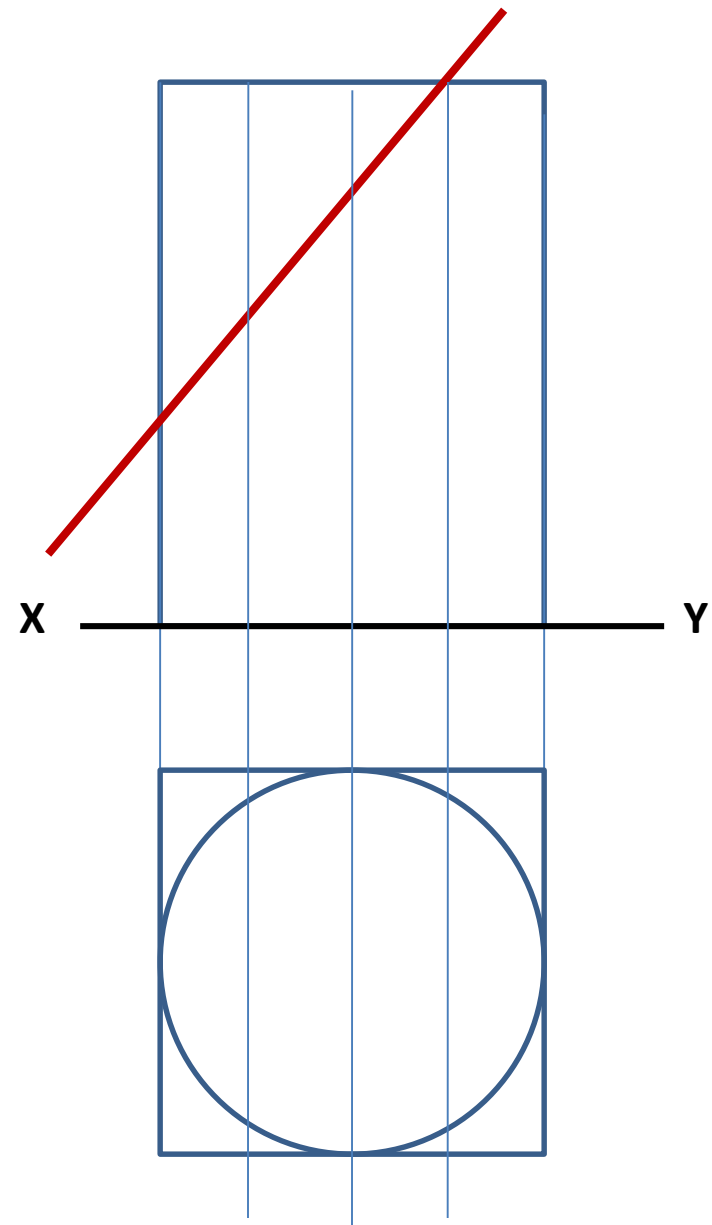

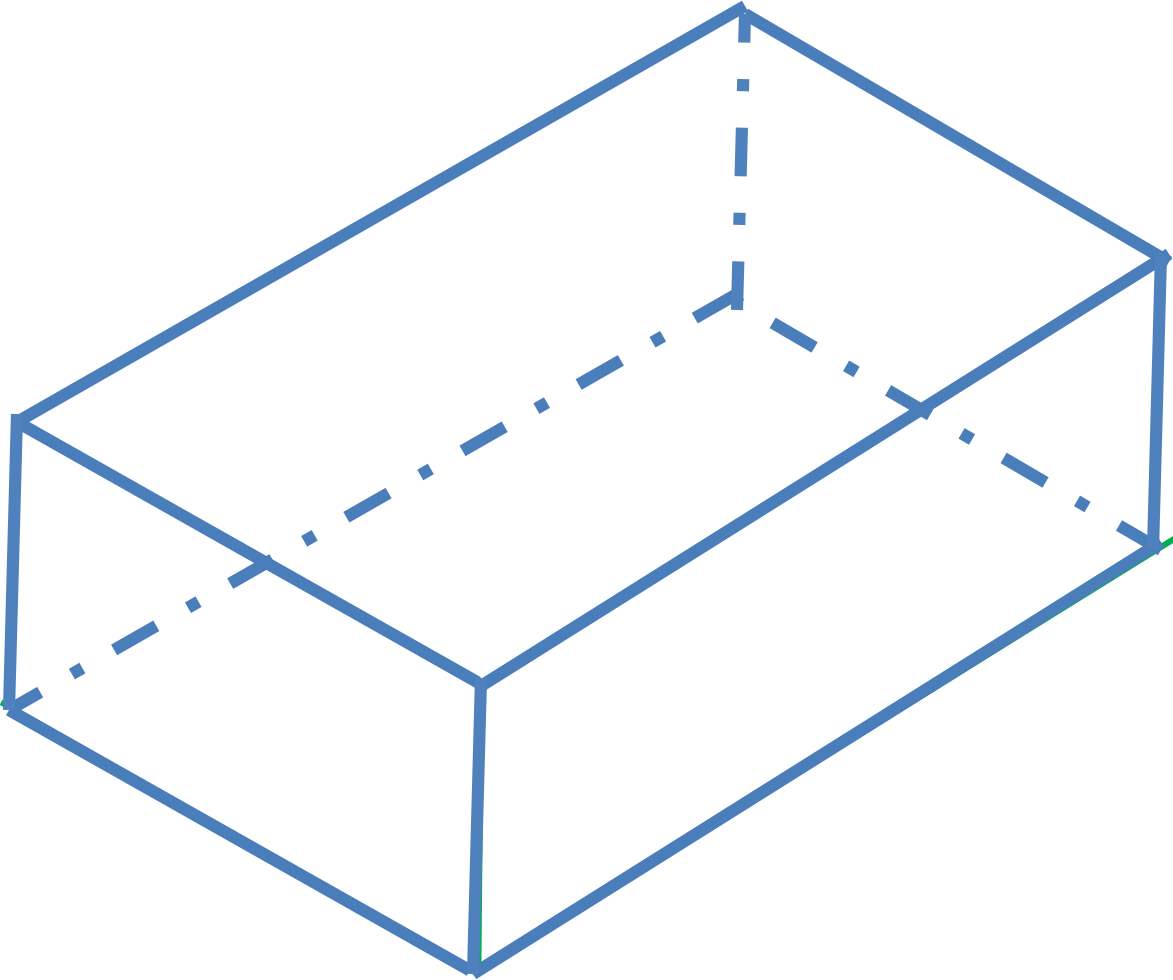

A

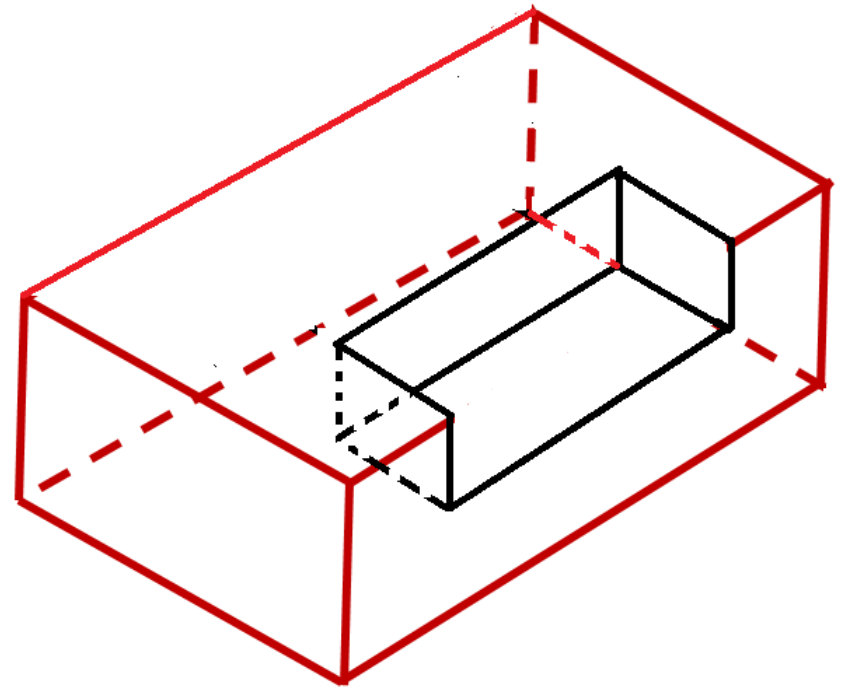
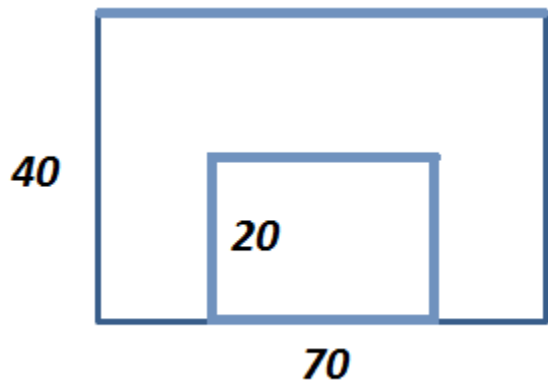
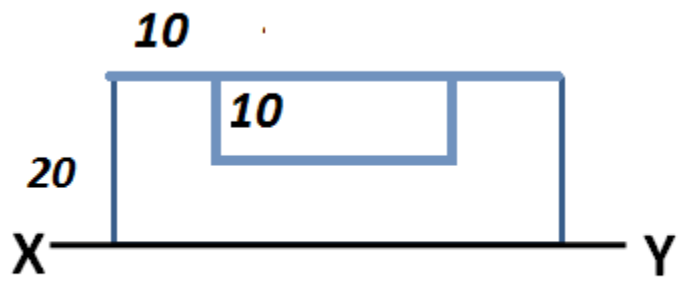

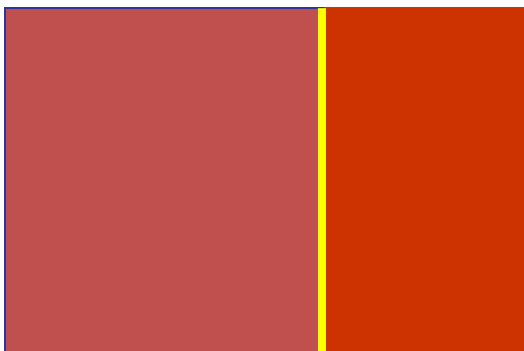

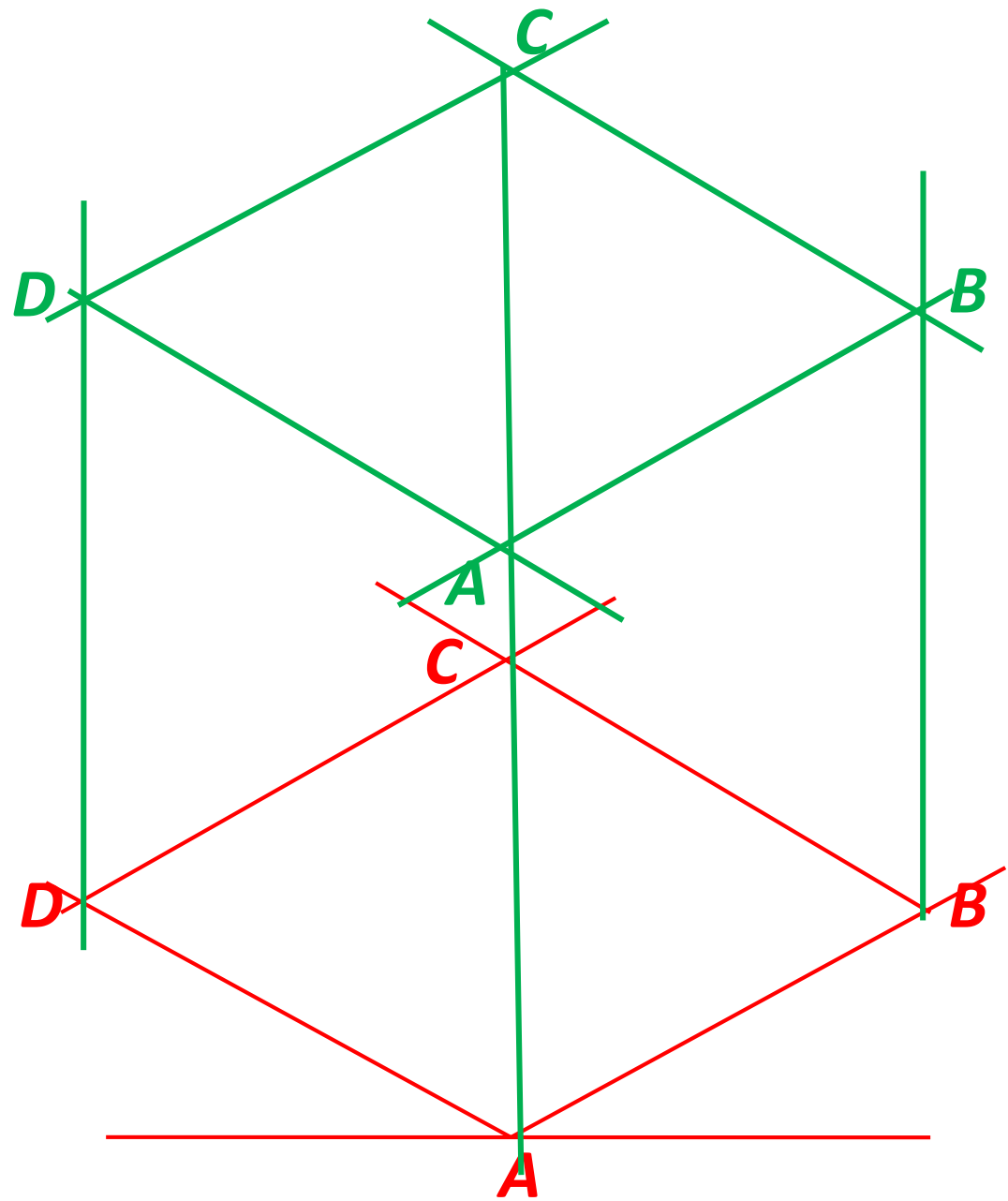

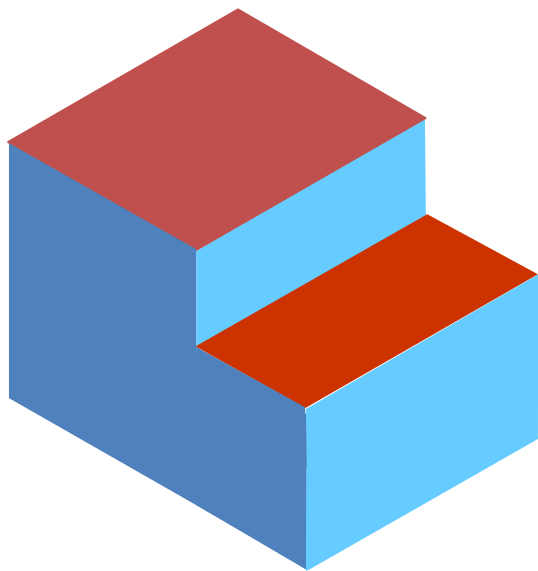
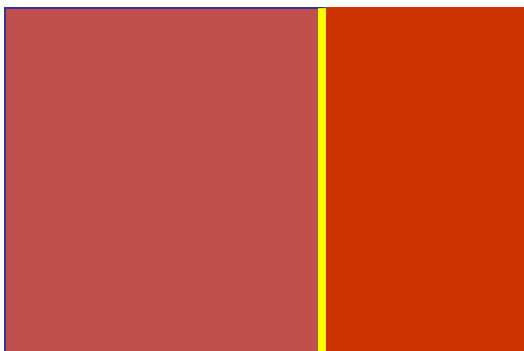

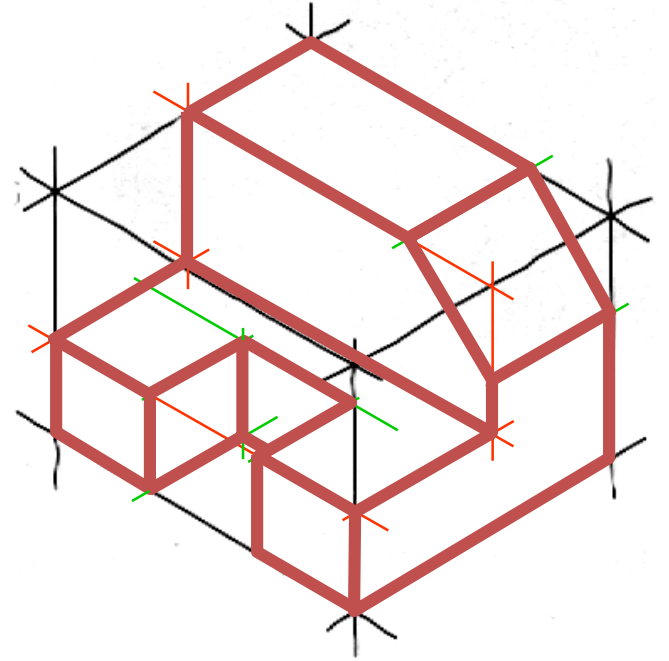

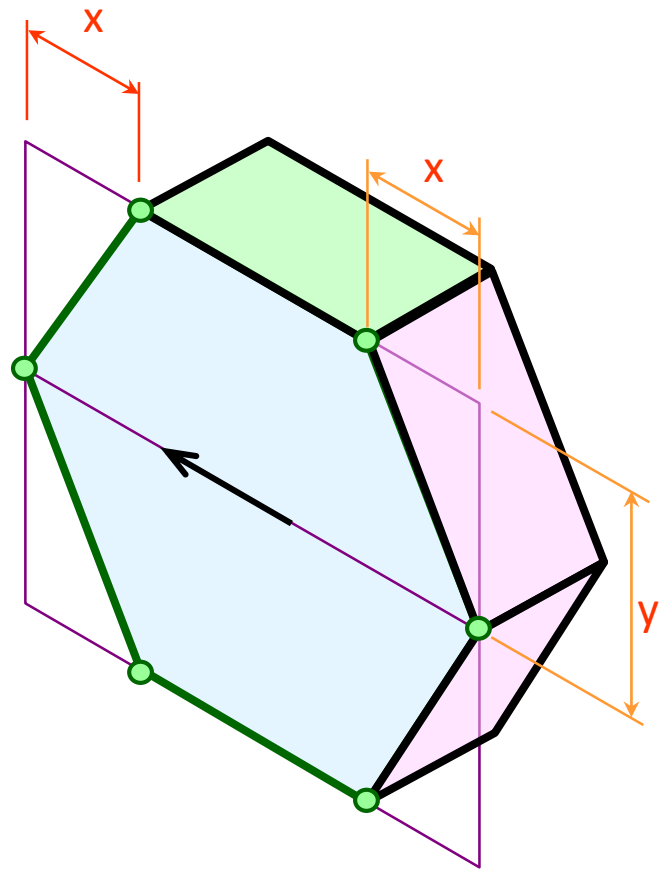

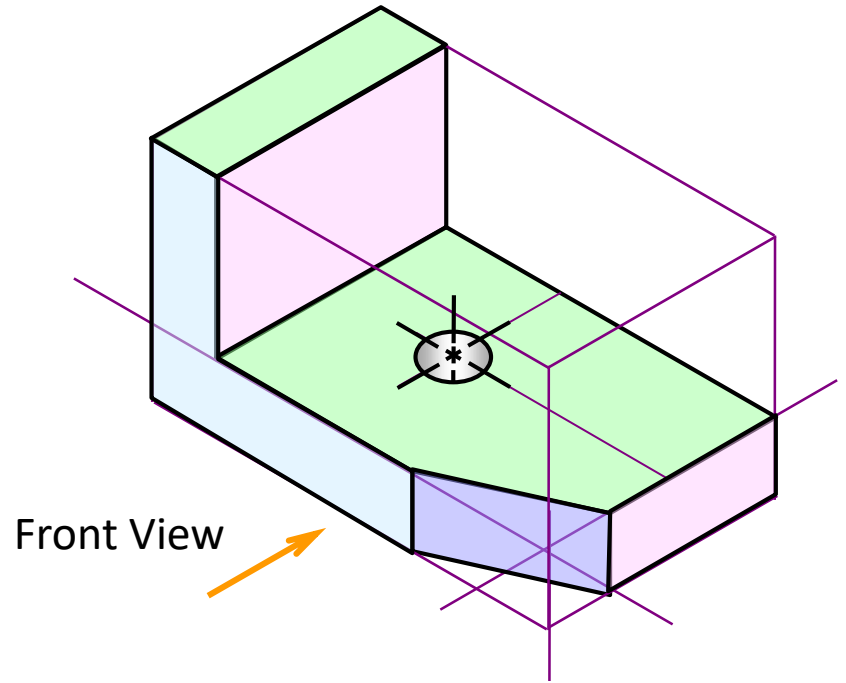

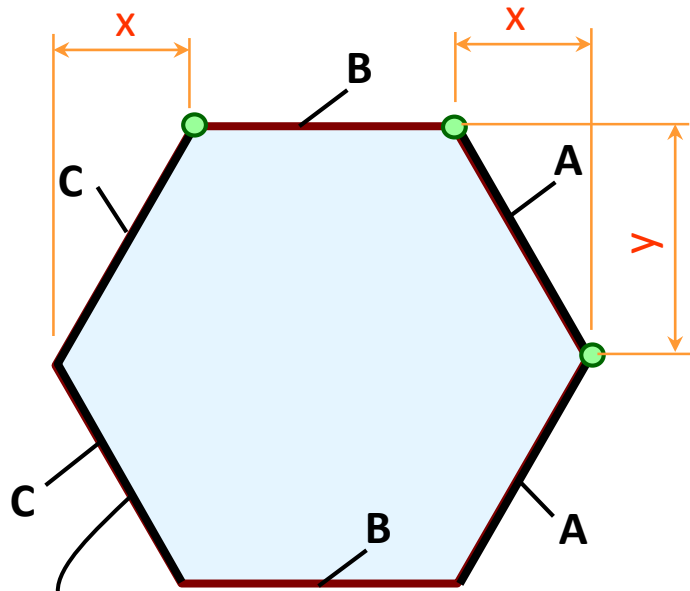

Nonisometric line

